

1SYSTEM®

TPMS User Guide

from

bf1systems

1SYSTEM@bf1systems.com

1 Modifications

Date	Modifications	Author	Version	Modified Sheets	Approved		
					By	Date	Signed
05/12/2024	Carried over from v1.9.2	GU	V1.10		GA	17/12/2024	GA
	Note to include Kvaser CAN hardware			7			
	Idle state update & State diagrams added			18			
	Factory Reset			35			
	Discover CAN note added			9			
17/12/2024	Help page TRA-063588/TRA-063741	GU	V1.10.1	11 95	Not Approved		
03/01/2024	Notes added for Idle state versions	GU	V1.10.2	18	Not Approved		
	Fuse rating added	GU		75			
03/04/2024	Table of figures removed	GU	V1.11	3	GA	29/04/2025	GA
	Send to bf1			11			
	Settings page info updated			27			
	ECU characteristics updated			33			
	Memo Tags updated			50			
	RSSI threshold for positioned system updated			62			
	Updating sensor configs updated			66			
	Projects updated			66			
Track Link Dongle	83						
27/05/2025	Additional information on robustness and resilience	GU	V1.11.1	41	GA	27/05/2025	GA
	IRTPMS State machine version corrected			18			
02/06/2025	Security overview update	GU	V1.11.2	6	Not Approved		
17/06/2025	Sensor Viewer details removed, and a separate guide written	GU	V1.11.3	30	GA	07/07/2025	GA
08/07/2025	Note to pressurise sensor for coms	GU	V1.11.4	10	GA	26/09/2025	GA
	P Ref manual reset CAN input added			36			
	FiA, IMSA& DTM series CAN receive			37			
29/09/2025	IR RBL zero ref temp setting updated	GU	V1.11.5	53	GA	29/09/2025	GA

2 Table of Contents

1	Modifications	2
2	Table of Contents	3
3	1SYSTEM® User Guide / App version	6
4	1SYSTEM® Licence Types	6
4.1	Licence overview	6
5	Quick Start Guide.....	7
5.1	1SYSTEM Support site	11
5.2	Send to bf1	11
6	Licence Expiry Notifications	12
7	1SYSTEM® TPMS General Information.....	13
7.1	1SYSTEM App Updates.....	14
7.2	Learning System.....	15
7.3	Positioned System	16
8	System Components	17
8.1	Wheel Sensor	17
8.2	Modes of the 1SYSTEM® TPMS Wheel Sensor	18
8.2.1	Dormant Mode	18
8.2.2	Slow Transmit Mode.....	18
8.2.3	Idle Mode (TPMS firmware v4.8 onwards / IRTPMS firmware v1.7 onwards)	18
8.2.4	Fast Transmit Mode.....	18
8.3	1SYSTEM® ECUs	20
8.3.1	ECU Lite.....	20
8.3.2	ECU Pro.....	22
8.3.3	ECU Corner or Position Assignment Pin Selection	23
9	Component Installation.....	24
9.1	General	24
9.1.1	Learning or Positioned 1SYSTEM® TPMS ?.....	24
9.1.2	Wiring	24
9.2	Learning 1SYSTEM® TPMS Installation Guidance	24
9.2.1	Wheel Arch Mounting – Front Engine	25
9.2.2	Wheel Arch Mounting – Rear Engine	25
9.2.3	Wheel Arch Mounting – Mid Engine.....	25
9.3	Positioned 1SYSTEM® TPMS Installation Guidance.....	26
10	Learning System Operation	26
11	1SYSTEM® Application Software	27
11.1	Installation and License Update.....	27
11.2	App settings.....	27
11.2.1	Offline sensor timeout.....	28
11.2.2	Sensor reference pressure	28
11.2.3	CAN settings	28
11.2.4	XCP broadcast ID.....	28
11.2.5	Temperature unit.....	28
11.2.6	Pressure unit	28
11.2.7	Car type.....	28
11.2.8	Sensor representation	28
11.2.9	Manual positioning	28
11.2.10	Show compensated pressure	29
11.2.11	Theme	29
11.2.12	Start page	29
11.2.13	SRW Mode	29
11.3	Car Page.....	30
11.4	Connected ECUs.....	31
11.4.1	Live Connection.....	31
11.4.2	Firmware Version.....	31
11.4.3	Errors	31
11.4.4	Pressure Warnings	31

11.5	ECU Detail View	32
11.5.1	Warnings and Errors	32
11.6	ECU Characteristics – Core Licence	33
11.6.1	Read, Write and Factory Reset	33
11.6.2	Firmware	33
11.6.3	Warnings	33
11.6.4	Wheel detection and confirmation	34
11.6.5	Licence management meta-data	34
11.7	ECU Characteristics - Core Plus Licence	35
11.7.1	Read, write and factory reset	35
11.7.2	Firmware	35
11.7.3	Licence management meta-data	35
11.7.4	CAN configuration message settings	35
11.7.5	CAN Receive message settings	36
11.7.6	CAN Transmit message settings	37
11.7.7	Diagnostics	38
11.7.8	General	39
11.7.9	License management	39
11.7.10	Warning limits	39
11.7.11	Wheel detection ans confirmation	40
11.8	Duplicate wheel and missing ECU detection (Robustness and Resilience)	41
11.8.1	Robustness	41
11.8.2	Resilience	41
11.9	ECU Firmware update	42
11.10	Wheel Sensor Detected by the ECU	43
12	1SYSTEM® Security	45
12.1	Updating Security Codes	46
12.2	Sensor Claiming	46
12.3	Claiming A Sensor Over the Wireless Connection	46
12.4	Claim Using Sensor Validation Code - SVC	47
12.4.1	Importing and exporting Claim lists	48
12.4.2	Memo Tags	50
12.4.3	Unclaim sensors	52
12.5	Updating Wheel Sensors	53
13	All Page	55
14	Near Page	56
15	Nearest Page	56
16	Pinned Page	57
17	IR Sensor Pixel selection	58
17.1	Pixel Layout	60
18	Positioned system setup	61
18.1	Setting ECU position	61
18.2	Setting sensor detection thresholds	62
18.3	Positioning wheel sensors	62
18.4	Activation & IR Activation Temperatures	63
18.5	Display sensor position in 1SYSTEM® App	64
18.6	Positioned system mounting on an open wheeled car	65
19	Projects	66
19.1	New Project	66
19.2	Updating Tyre Sets	68
19.3	Update single sets using projects	70
19.4	Update a single sensor using projects	72
19.5	Batch updating sets using projects	72
19.6	Batch updating single sensors using projects	73
19.7	ECU Update using projects	73
20	Confirming Acceptable Reception of Each ECU	74
21	1SYSTEM® ECU Wiring Schematic	75

22	CAN Specification	76
23	System Errors and Warnings.....	77
24	Tyre pressure warnings.....	79
24.1	Gauge / absolute pressure (CAN signal 'TPM1S_XX_WS_PRESS').....	79
24.2	Compensated pressure (CAN signal 'TPM1S_XX_WE_P_COMP')	79
24.3	Reference pressure (CAN signal 'TPM1S_XX_WE_P_REF')	79
24.4	Flat tyre warning (CAN signal 'TPM1S_XX_WS_RUN_FLAT_WRN')	79
24.5	Low pressure soft warning (CAN signal 'TPM1S_XX_WS_PRESS_SOFT_WRN')	79
24.6	Low pressure hard warning (CAN signal 'TPM1S_XX_WS_PRESS_HARD_WRN')	79
24.7	Rapid pressure loss warning (CAN signal 'TPM1S_XX_WS_GAS_LOSS_WRN')	79
25	ECU product markings.....	80
25.1	Lite ECU	80
25.2	Pro ECU.....	80
26	Wheel sensor product markings.....	81
26.1	TPMS sensor.....	81
26.2	IRTPMS Sensor	82
27	bf1system Track Link dongle.....	83
28	Valve and Sensor Fitting Instructions	84
28.1	Tools Required	86
28.2	Valve Kit Parts	86
28.3	Valve Installation.....	87
28.4	Fitting the 1SYSTEM® IR Using the High Strength Bolt Kit.....	88
28.5	Fitting Notes.....	90
29	Recommended Procedures and Maintenance.....	91
29.1	Preserving Wheel Sensor Battery Life	91
29.2	Wheel Cleaning	91
29.3	Buying or selling a system from another team	91
30	Troubleshooting	92
30.1	SRW (Short Range Wireless) not connecting	92
30.2	Sensor fails configuration update	92
30.3	No CAN connection to ECU	92
30.4	No CAN connection following application restart	93
30.5	Sensor displayed freezes	93
30.6	Licence not recognised	93
30.7	1SYSTEM app will not run	94
31	Certifications	95
31.1	Brazil	95
31.2	TRA-063588/ TRA-063741 Safety testing.....	95

3 1SYSTEM® User Guide / App version

This user guide is to be used in association with the 1SYSTEM PC app version V1.11.

4 1SYSTEM® Licence Types

4.1 Licence overview

Feature	Licence type			
	Unlicenced	Sensor Viewer	Core	Core Plus
Car view page			x	X
All sensors page		Note 1		X
Near sensors page		X		X
Nearest sensors page		X		X
Pinned sensors		X		X
Projects				X
Security management			X	X
Firmware update			X	X
Sensor claiming		X		X
App settings page		Note 2	X	X

Note 1:

Filter options limited to 'Connection State, Battery and Sensor type
Sort by limited to RBL and Signal strength
No Pressure or Temperature readings will be displayed

Note 2:

Setting page limited to:
Offline sensor timeout
Sensor representation (serial number displayed as Dec or MAC)
App theme

A Sensor Viewer user guide can be requested on the 1system@bf1systems.com email.

5 Quick Start Guide

When you receive your delivery of 1SYSTEM® Tyre Pressure & Temperature Monitoring System components, the kit will include the wheel sensors corresponding to the system you ordered, ECUs with integrated antennas and the valves to mount the sensor to your wheel rims. The installation instructions for the valves and sensors can be found in Section 27 of this document.

The guidelines for installing the ECUs can be found in Section 9 of this document.

To download the 1SYSTEM® TPMS PC software, email 1SYSTEM@bf1systems.com and a link will be sent to you.

After installation of the software, a license request will need to be sent to 1SYSTEM@bf1systems.com

The PC software is required to communicate with the TPMS ECU and to configure the wheel sensors. Further information can be requested by emailing the same address.

The 1SYSTEM® TPMS ECU uses a CAN connection to communicate with the PC. Vector, Peak Systems USB-to-CAN and Kvaser hardware interfaces are supported and are required for the ECUs.

The internal Bluetooth used by the PC or tablet is supported by the software, but due to this using a common chipset with the WiFi, an external Bluetooth adaptor should be used to communicate with the sensors.

On first installation, the 1SYSTEM® App software will open with a Demo license and no CAN connection.

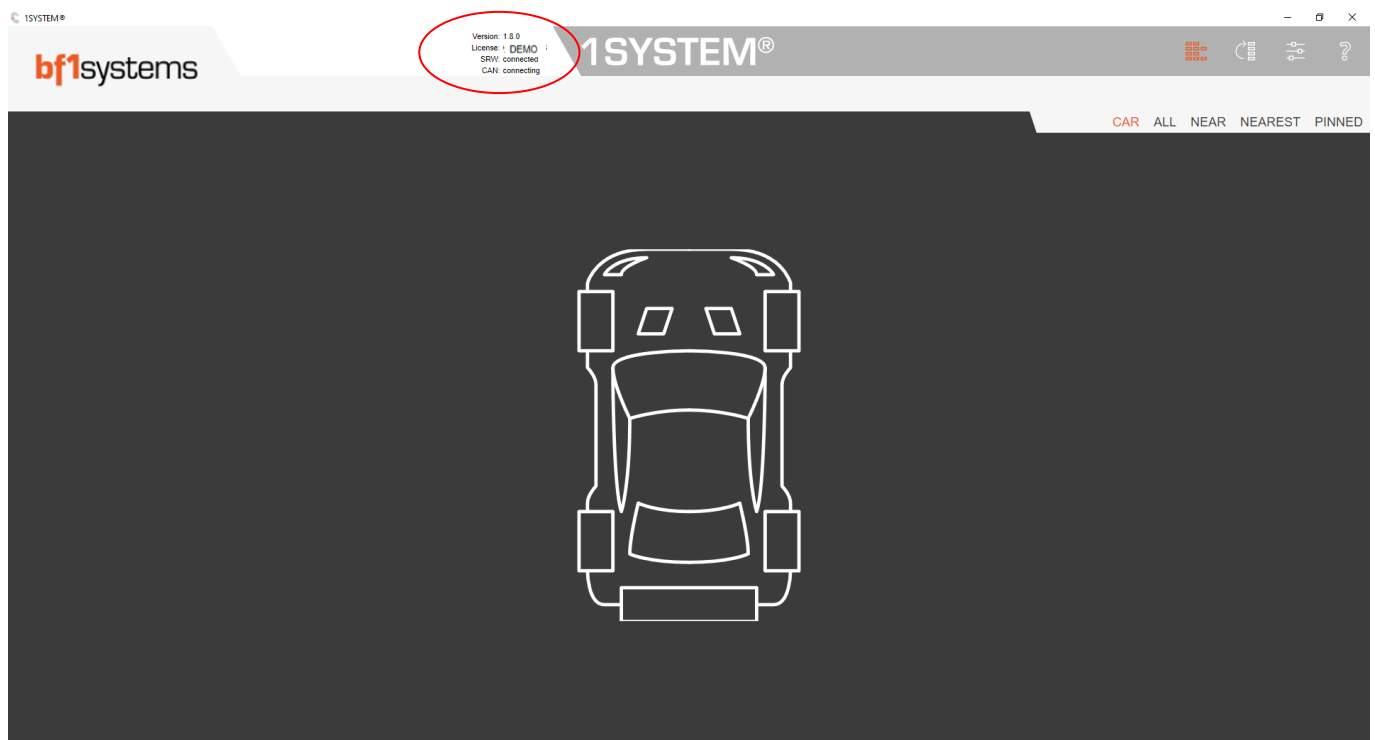

Figure 1 - 1SYSTEM® App demo mode

To activate the version of 1SYSTEM® App purchased, or to update the license in case of expiry, and to include the security codes required to manage your devices you will need to generate a license request file. To do this, navigate to the 'License' page, this can be accessed by either clicking where it shows the current license (Demo on the screen above) or by selecting the 'Application' settings menu.

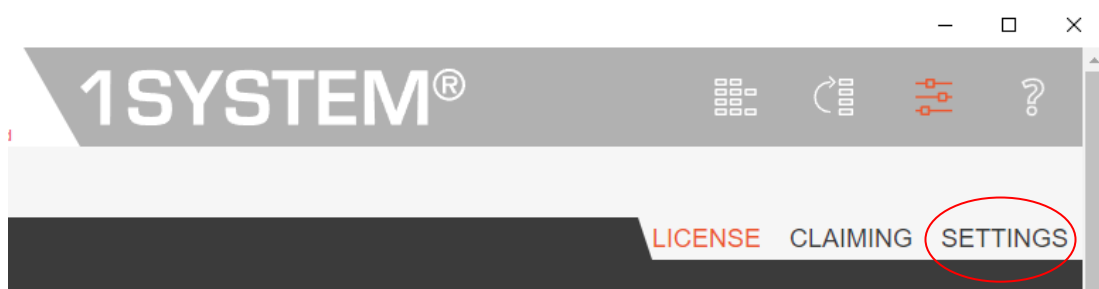

Figure 2 - Application settings button

At the bottom of the license page there is a 'Generate License Request File' button. Press this button, save the file and send it to 1SYSTEM@bf1systems.com.

The 1SYSTEM® Core license can be requested free of charge, but you will need the Core Plus license if you want to use the full functionality detailed in this User Guide. Please contact sales@bf1systems.com to order the Core Plus annual license.

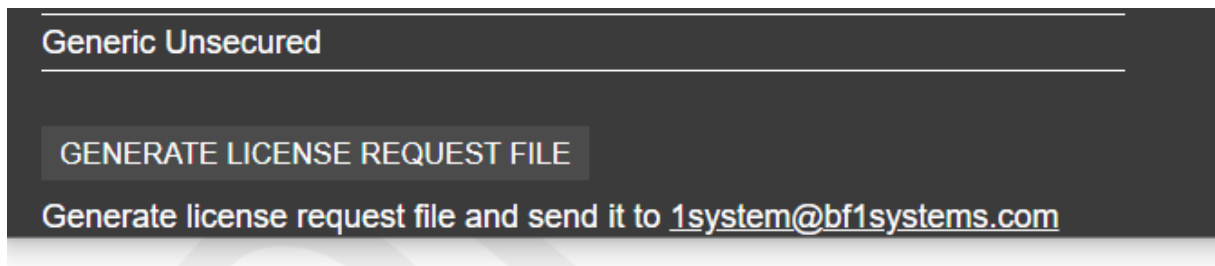

Figure 3 - Generate License Request File button

When you receive confirmation that the licence has been activated, the next time the App is opened (with Internet connection), the licence page will refresh automatically to show your licence status.

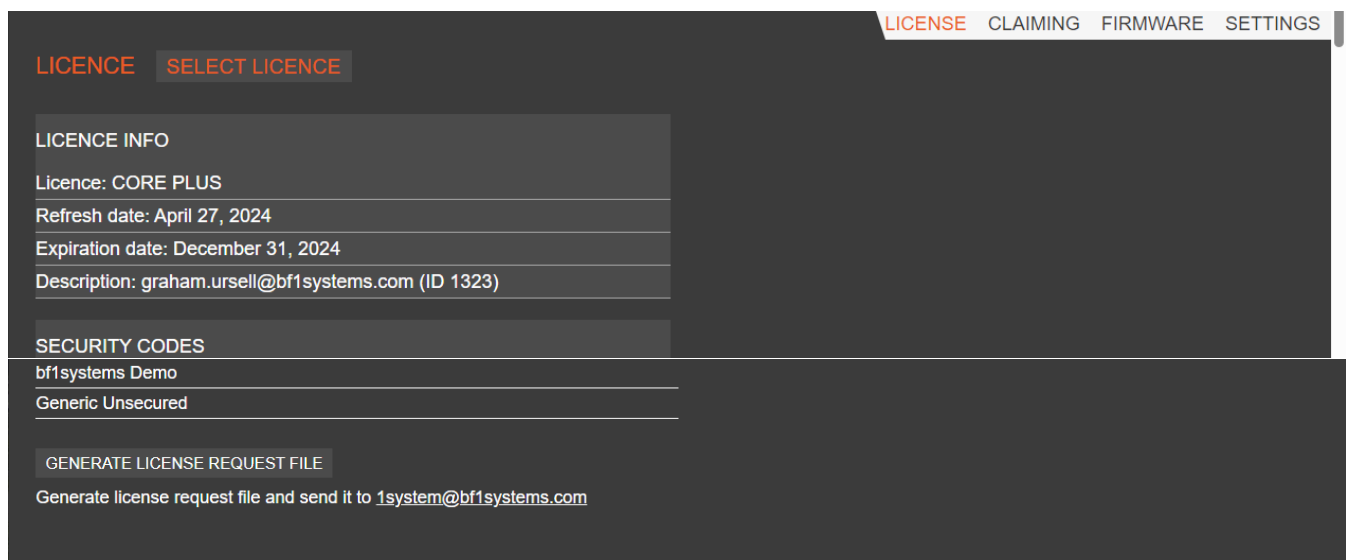

Figure 4 - Example of License update

To configure the CAN communications, select 'Settings' tab on the Applications Configuration page, select the required CAN adapter manufacturer, the CAN adapter type and the CAN channel if using a multi-channel device, all other settings can remain set to default and updated later if needed.

When finished, save the settings using the *Save Settings* button.

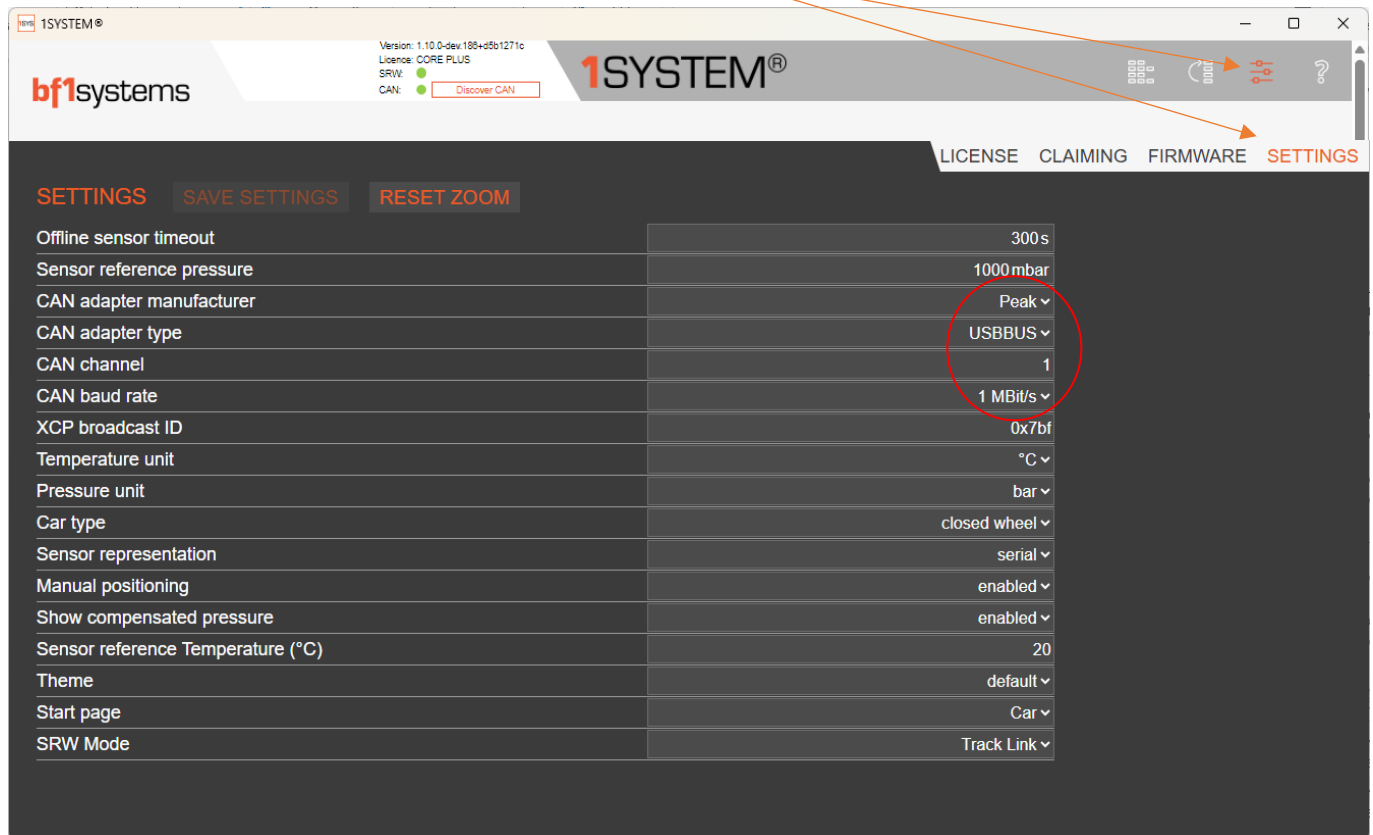

Figure 5 - CAN settings

Please ensure any drivers needed for the CAN adapter are installed.

Note: For Peak P-CAN, please ensure the PCAN Basic API is installed.

With the CAN adapter plugged into the PC, and at least one ECU connected to the CAN adapter, click where the CAN status shows as disconnected to update and connect to the system.

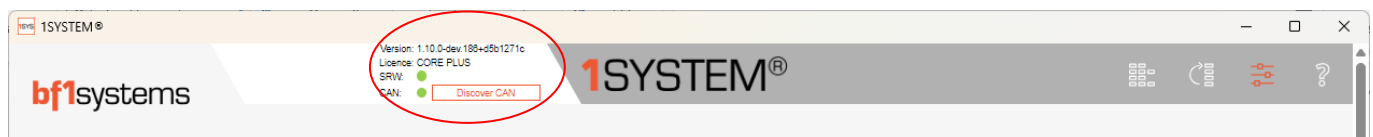

Figure 6 - CAN connection status

NOTE: the 1SYSTEM® App will not show as CAN connected unless there is at least one ECU connected and powered

If the CAN IDs for the data transmitted from the ECUs have been changed from the default, use the Discover CAN button, this will read the IDs used from the ECU and show the data using those.

When connected, return to the 'Devices Overview' page then browse to the 'CAR' tab and the screen will show the connected ECUs and the detected sensor for each ECU.

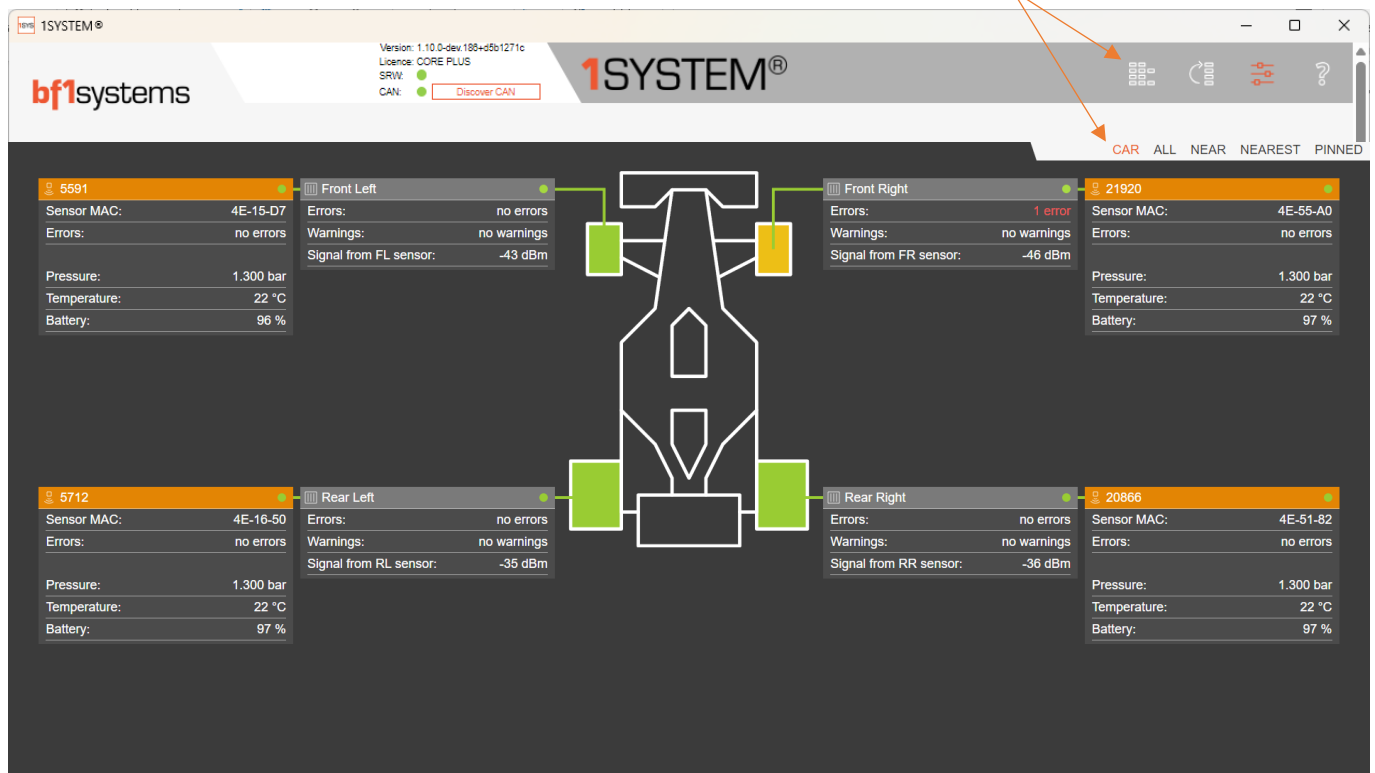

Figure 7 - CAR page

Communication with the ECUs will require a direct connection using the CAN adaptor, there is no 2.4GHz wireless communication between the 1SYSTEM® App and the ECUs.

Direct communications between your PC/laptop/tablet with the wheel sensors take place using a 2.4GHz wireless connection. Therefore, it is necessary for you to either have a built in 2.4GHz wireless device, or for an external receiver dongle to be plugged into your computer.

Note: when using an external Bluetooth dongle, the internal device will need to be disabled in the Windows Device Manager.

When communicating directly with wheel sensors using the 2.4GHz wireless connection, it is strongly recommended that any existing devices that may be communicating with the PC using a Bluetooth connection, such as headphones or a mouse, are disabled as these will significantly slow down the communication with the wheel sensor.

It is also recommended that if you have built in computer hardware receiver which supports 2.4GHz, and you understand where in your computer the antenna is, because some functions of 1SYSTEM® rely on having a strong signal strength, and being able to orientate your computer so the 2.4GHz wireless hardware is nearest to the wheel sensor, will help.

To communicate with the sensors and make any changes, the sensors must be pressurised.

5.1 1SYSTEM Support site

Accessing the 1SYSTEM Support site allows you to download the latest software, datapacks, user guide, technical documents and release notes. Please click the 'Help' button (?) in the top right of the 1SYSTEM App.

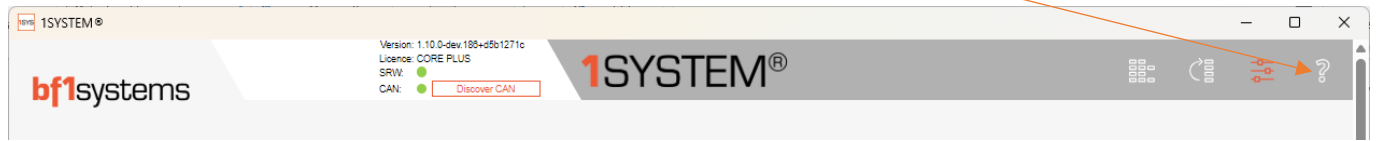

Figure 8 – 'Help' Button

Using this button will take you to our website:-

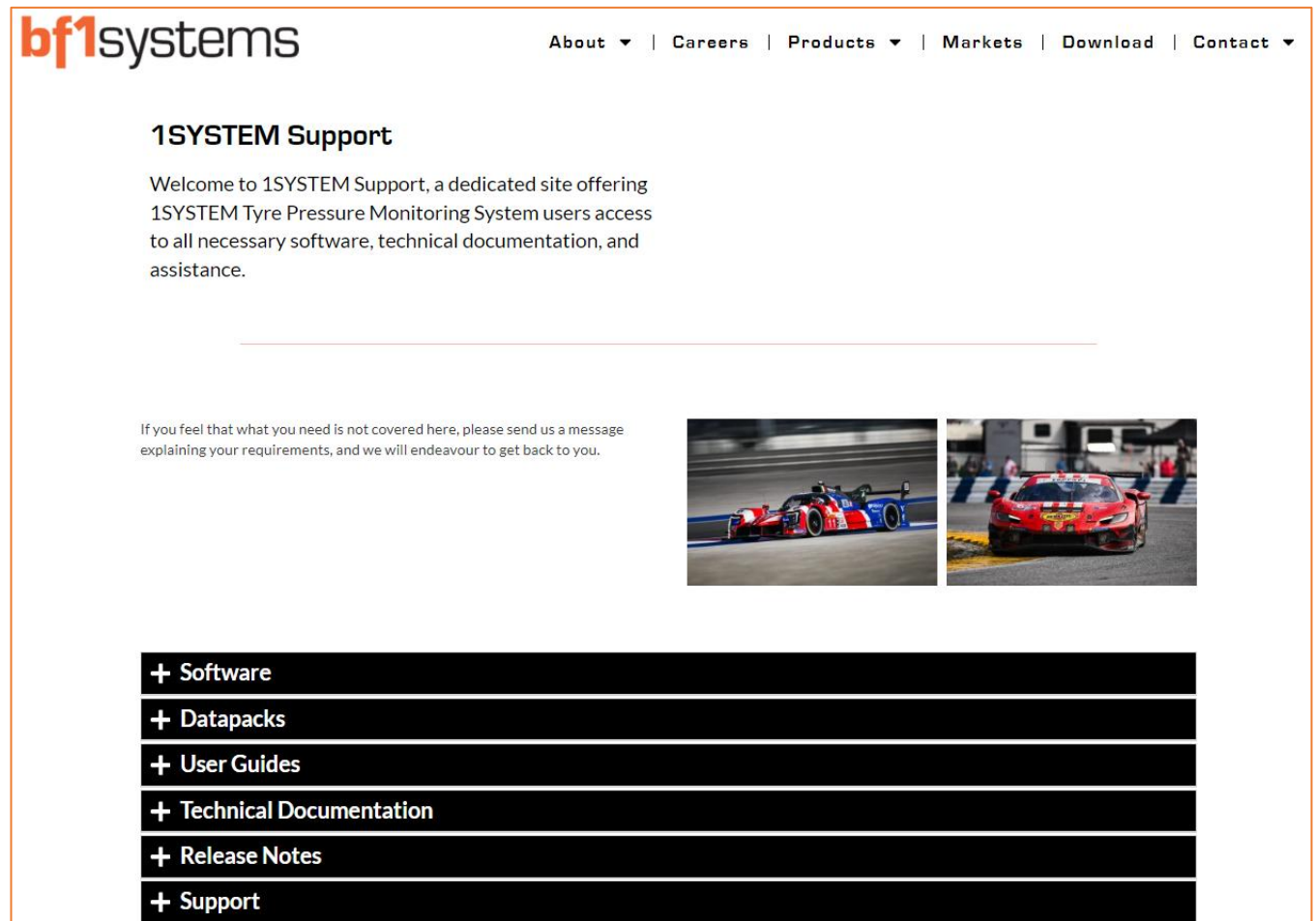

Figure 9 – 1SYSTEM Support Site

5.2 Send to bf1

For sensors that display errors you will find a *send to bf1* button on the sensor characteristics page, when used, the software will attempt to read all the characteristics from the sensor and send the information directly to bf1systems for analysis. Please contact bf1systems directly to inform that a file has been sent.

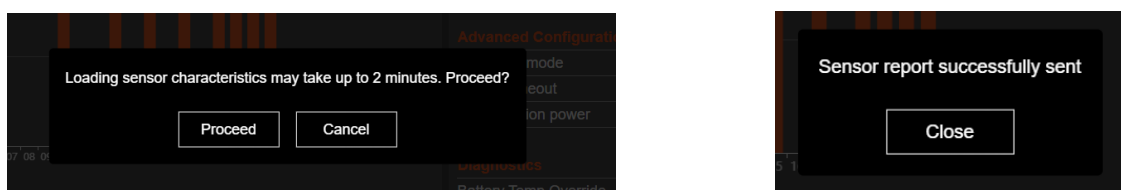

Figure 10 - Send to bf1 confirmation

6 Licence Expiry Notifications

The time remaining on your 1SYSTEM® licence can be viewed by selecting the licence page in the SETTINGS page of the app.



Figure 11 - Licence remaining

To warn the user of the licence expiry, the licence type text will change to Orange when the licence is 7 days from expiry

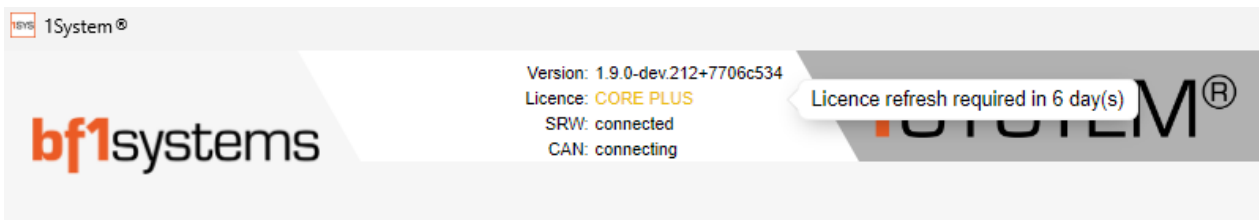

Figure 12 - 7 days from expiry

The licence type text will change to Red when the licence is 3 days from expiry

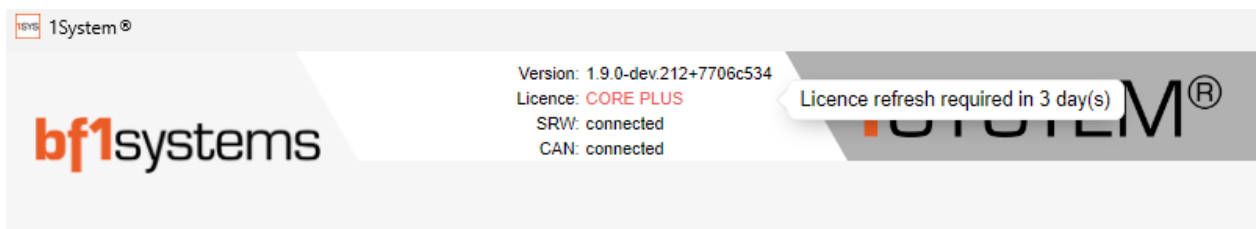

Figure 13 - 3 days from expiry

The app will also require connection to the licence server once a month to refresh the details, this is also shown on the licence page and by hovering over the licence type at the top of the page.

7 1SYSTEM® TPMS General Information

The TPMS is part of the 1SYSTEM® product range, which is a new generation of products developed by bf1systems utilising the 2.4GHz frequency for wireless communications. The ECU is intended to be used as the 'core' product and central to evolving a vehicle sensor ecosystem.

The 1SYSTEM® Tyre Pressure Monitoring System (TPMS) consists of:

- 2.4GHz wheel sensors
- Motorsport valve (specified for each customer's rim detail)
- ECU with integrated antenna
- Wiring Harness (vehicle specific)
- PC Software - with corresponding license

The 1SYSTEM® TPMS has been specifically developed to meet demanding applications where the vehicle and support team require fast and accurate tyre pressure and temperature data from their wheel electronics. To achieve this, bf1systems have developed the wheel electronics to be even more intelligent to their surroundings – this has been achieved by utilising 2.4GHz functionality and an on-board accelerometer. The wheel electronics contain a battery, absolute pressure sensor, temperature sensor, accelerometer, micro controller, radio frequency (RF) transmitter, and two Infra-Red elements (only present on 1SYSTEM® IR sensors) – all housed in the smallest and lightest housings on the market.

The wheel electronics are mounted onto the rear of a bf1systems supplied valve, or onto a custom stud.

The wheel sensors transmit data at different rates depending on the environmental conditions. All sensors undertake more processes and transmit data when pressurised, meaning that between events it is highly recommended that sensors are deflated in order to preserve the battery life.

Note:- Failure to deflate tyres between events will lead to significantly shortened sensor battery life.

Table 1 shows the three states the wheel sensor operates in, and the conditions which need to occur for each state to be active.

Mode	Pressure (Bar Gauge)	Roll switch	Transmission Rate
Storage	< 0.115	< 30kph	No Transmission
Idle	> 0.115 (constant for 36 hrs) & < 30kph (for 36 hrs)		Every 30 seconds
Stationary	> 0.115	< 30kph	Every 3 seconds
Moving	> 0.115	> 30kph	Determined by sensor type (see next table)

Table 1 - Wheel Sensor transmission modes

Wheel Sensor	Moving Transmission Rate [s] Pressure and Air Temperature	Moving Transmission Rate [s] Infrared Tyre Temperature
F1-XXX-1800-002 Wheel Sensor Lite	3	-
F1-XXX-1800-003 Wheel Sensor Pro	1	-
F1-XXX-1850-001 IRTPTMS Wheel Sensor Lite	1	1
F1-XXX-1850-002 IRTPTMS Wheel Sensor Pro	1	1

Table 2 - Wheel Sensor Moving transmission rates

NOTE: for generic parts insert 100 for the XXX, for customer specific parts the XXX will reflect your customer number.

The 1SYSTEM® TPMS can be configured in one of the following ways, depending on the application.

- Learning System: the TPMS can automatically detect which wheel sensor is fitted to each position of the car and starts monitoring it. This requires the fitment of four ECU Antennas to be fitted to the car.
- Positioned System: where specific wheel sensors are assigned to positions on the car. This requires the fitment of between one and four ECU Antennas to be fitted to the car, depending on the application and vehicle construction.

7.1 1SYSTEM App Updates

When a new version of the 1SYSTEM app is released, an update notification will be shown when the App is opened, use the Download button to receive the update, it will need to be installed from the Downloads folder.

To dismiss the update and use the software, click on the OK button.

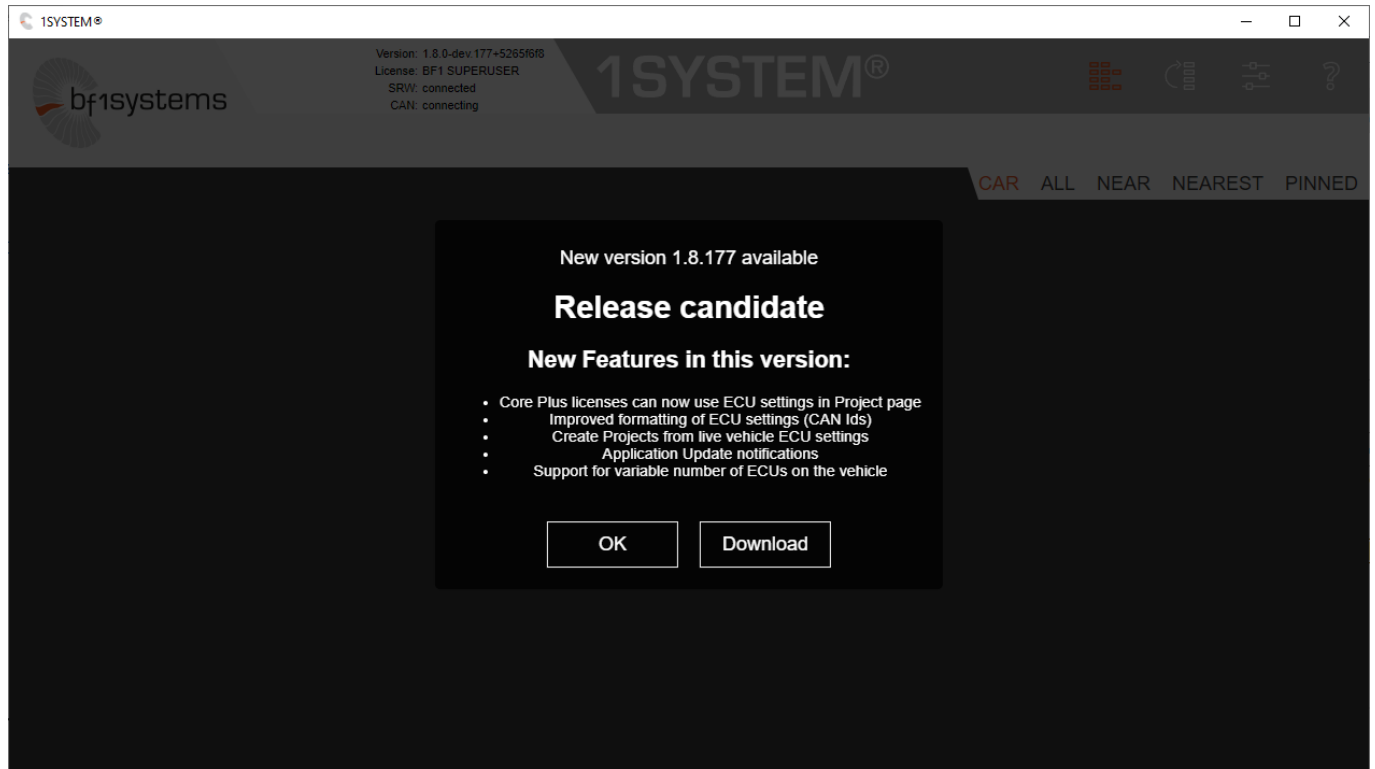

Figure 14 - Update notification

7.2 Learning System

The 1SYSTEM® learning function of the TPMS provides teams with a fit and forget Tyre Pressure Monitoring System (TPMS) due to its ability to automatically learn the wheel sensors fitted to the car, and start monitoring them, without the user having to manually allocate sensors to specific corners.

The learning system consists of four 2.4GHz ECU Antenna units, one of which is located near each wheel sensor.

Each ECU functions as an individual sub system of the complete TPMS, the corner identification of the specific ECU on the vehicle is designated by pin assignment within the mating connector. See the wiring schematic in Section 21 for further details.

The ECU receives datagrams from each sensor within range and uses the signal strength to determine which sensor is nearest, the ECU then selects that sensor and transmits the sensor data received over the CAN bus.

Using this method, the system can detect and transmit the sensor data from when the wheels are fitted to the vehicle, and update when the wheels are changed.

When the speed received on CAN is above the Moving Speed for 8 seconds, the system confirms the sensors detected as fitted to the vehicle. The sensors will remain confirmed until the Vehicle speed falls below the specified threshold or the sensor is no longer detected.

Learning systems can be used on all vehicles, closed and open wheel, but four ECUs must be installed on the car.

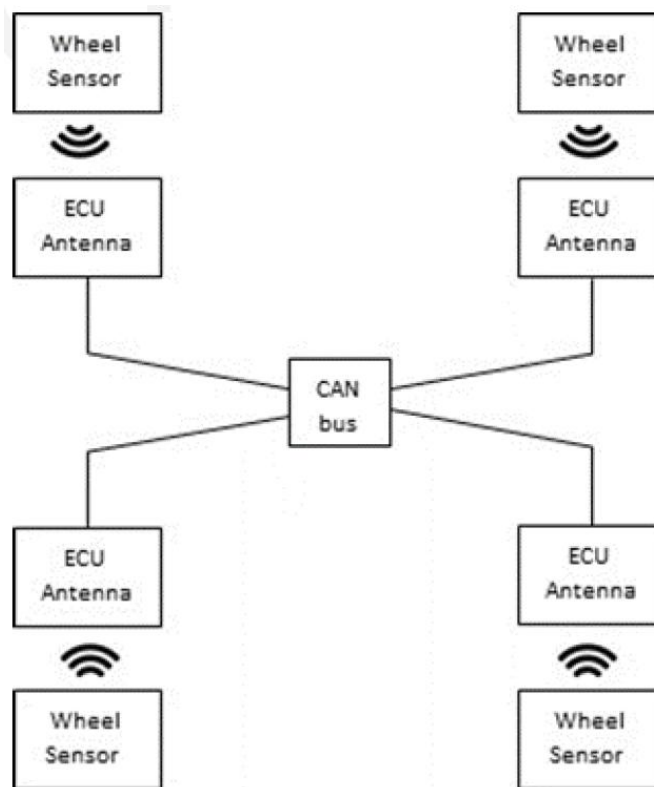

Figure 15 - Learning system architecture

7.3 Positioned System

The bf1systems positioned system is suited for applications where the user does not want to install four ECUs, or it is not practical to do so. The positioned system supports a one, two, three and four ECU layout or system architectures, depending on the type of vehicle, and the positions available to install the ECUs on the vehicle.

With the 1SYSTEM® positioned system, it is no longer necessary to position the wheel sensor serial numbers to corners of the car and write this data into the chassis mounted ECUs. Instead, the wheel sensors themselves are wirelessly programmed with positions and set numbers. This has the advantage that if a wheel sensor position needs to be changed, it is no longer necessary to connect to the car to update a position file, and instead the sensor itself only has to be updated, saving time and simplifying this procedure.

See section 18 for setup of a positioned system.

8 System Components

8.1 Wheel Sensor

Each sensor contains a battery, radio frequency (RF) transmitter, absolute pressure sensor, temperature sensor, an accelerometer and two Infra-Red elements (only present on 1SYSTEM® IR sensors). The accelerometer is used to detect when the wheel is rotating, enabling the moving transmit mode.

The wheel sensors are contained in a PEEK™ housing and are designed to survive the high temperatures and g loadings found in motorsport.

Multiple sensor types are available, and include:

- 1SYSTEM® Lite TPMS - 25mbar Resolution - 0.33Hz Transmission
- 1SYSTEM® Pro TPMS - 12.5mbar Resolution - 1Hz Transmission
- 1SYSTEM® Lite IRTPTMS - 12.5mbar Resolution - 1Hz Transmission, 8 IR measurement points
- 1SYSTEM® Pro IRTPTMS - 5mbar Resolution - 1Hz Transmission, 28 IR measurement points

Pressure accuracy - ± 25 mbar

Sensor weights:

- 1SYSTEM® TPMS 15g
- 1SYSTEM® IR TPMS 36g

Wheel sensors can be claimed and programmed with a security code by teams to allow only themselves to view sensor data, which prevents any competitors from seeing data from these sensors. Wheel sensors can be claimed to the 1SYSTEM® app. The sensor validation code (SVC) is used to claim the sensor, and this is engraved on the sensor housing, as highlighted in orange in Figure 16. Claiming instructions can be found in Section 12.2.



Figure 16 - Sensor Validation Code (highlighted in orange)



Figure 17 - 1SYSTEM® TPMS Sensor



Figure 18 - 1SYSTEM® IRTPTMS Sensor

NOTE: Valve kits are supplied separately and not part of the wheel sensor assembly.

8.2 Modes of the 1SYSTEM® TPMS Wheel Sensor

8.2.1 Dormant Mode

All sensors are shipped from the factory in the dormant mode. This means they are not transmitting data to preserve battery life. The sensor measures air pressure in this state and will change their state when the air pressure is above 0.115bar gauge.

When the sensor detects a pressure change in the tyre that takes the pressure below 0.115bar, the sensor will continue to transmit for 60 seconds before returning to dormant mode.

When in this mode, the sensor can transition into fast mode if the accelerometer is set.

8.2.2 Slow Transmit Mode

Once the sensor is fitted to the rim and the tyre inflated above 0.115bar gauge, the sensor will transition into a slow transmit state.

In this slow transmit state the sensor will transmit data at regular intervals. The accelerometer is used to detect when the wheel is rotating above approximately 30kph and at this point transitions the sensor into Fast Transmit Mode.

8.2.3 Idle Mode (TPMS firmware v4.8 onwards / IRTPMS firmware v1.7 onwards)

A sensor fitted in a tyre that remains inflated will continue to transmit in Slow Transmit mode for 36hrs, if during this time, the sensor does not detect movement or a change in pressure >350mbar, continuously for 5s, it will enter Idle mode where it will not transmit, this state will increase battery life of the sensor.

Setting the accelerometer by wheel rotation, or a change in pressure >350mbar for > 5s, will transition the sensor to Fast Transmit mode.

NOTE: v4.8 and v1.7 may not be available to all customers

NOTE2: Pressure change of 350mbar is a compensated delta value from the moment that the sensor entered IDLE state. This means that if the temperature of the sensor is subsequently warmer, the delta required will be less, and if the temperature is colder then the delta required will be greater.

8.2.4 Fast Transmit Mode

Once wheel rotation has been detected the sensor enters fast transmission mode where pressure, temperature and IR element datagrams are transmitted at the fastest rate.

The sensor will continue to transmit in fast mode for 60 seconds following the wheel becoming stationary (speed <30kph).

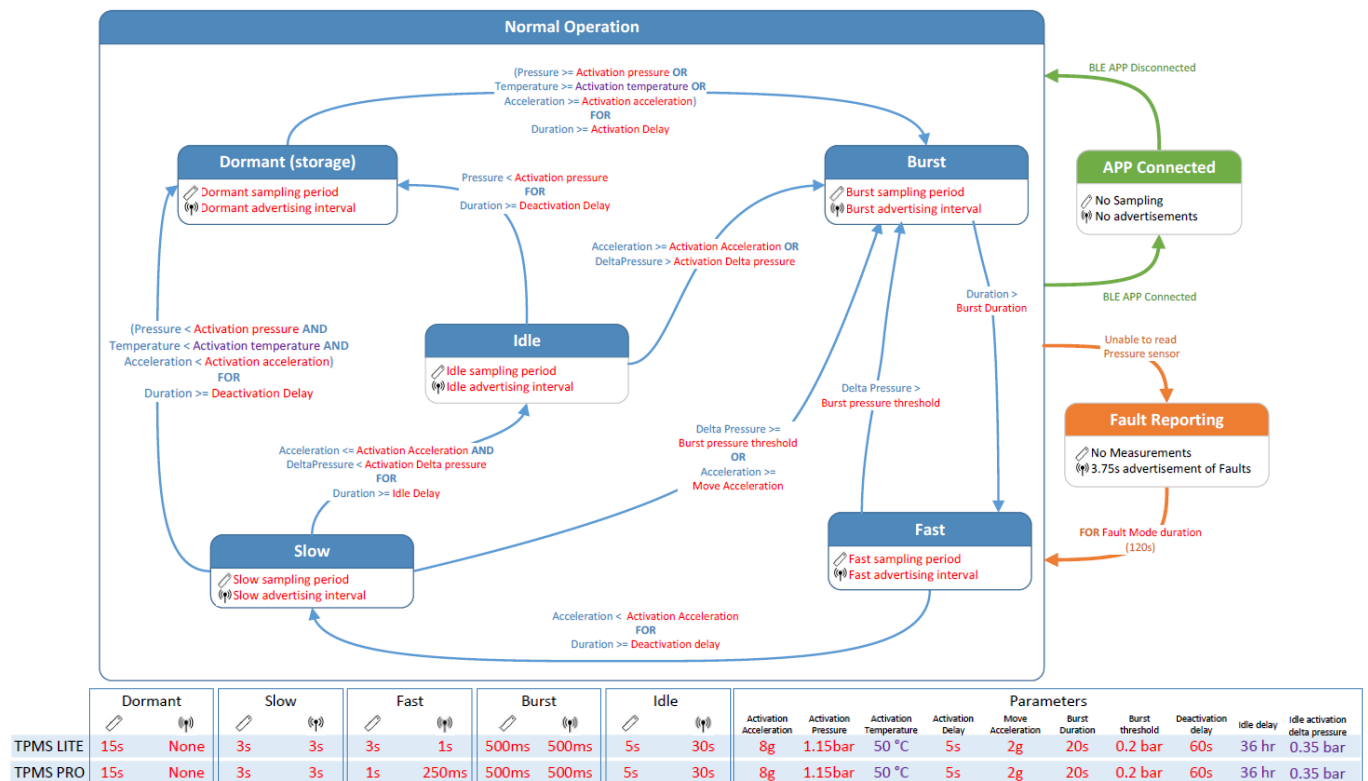

Figure 19 - TPMS v4.8 state diagram

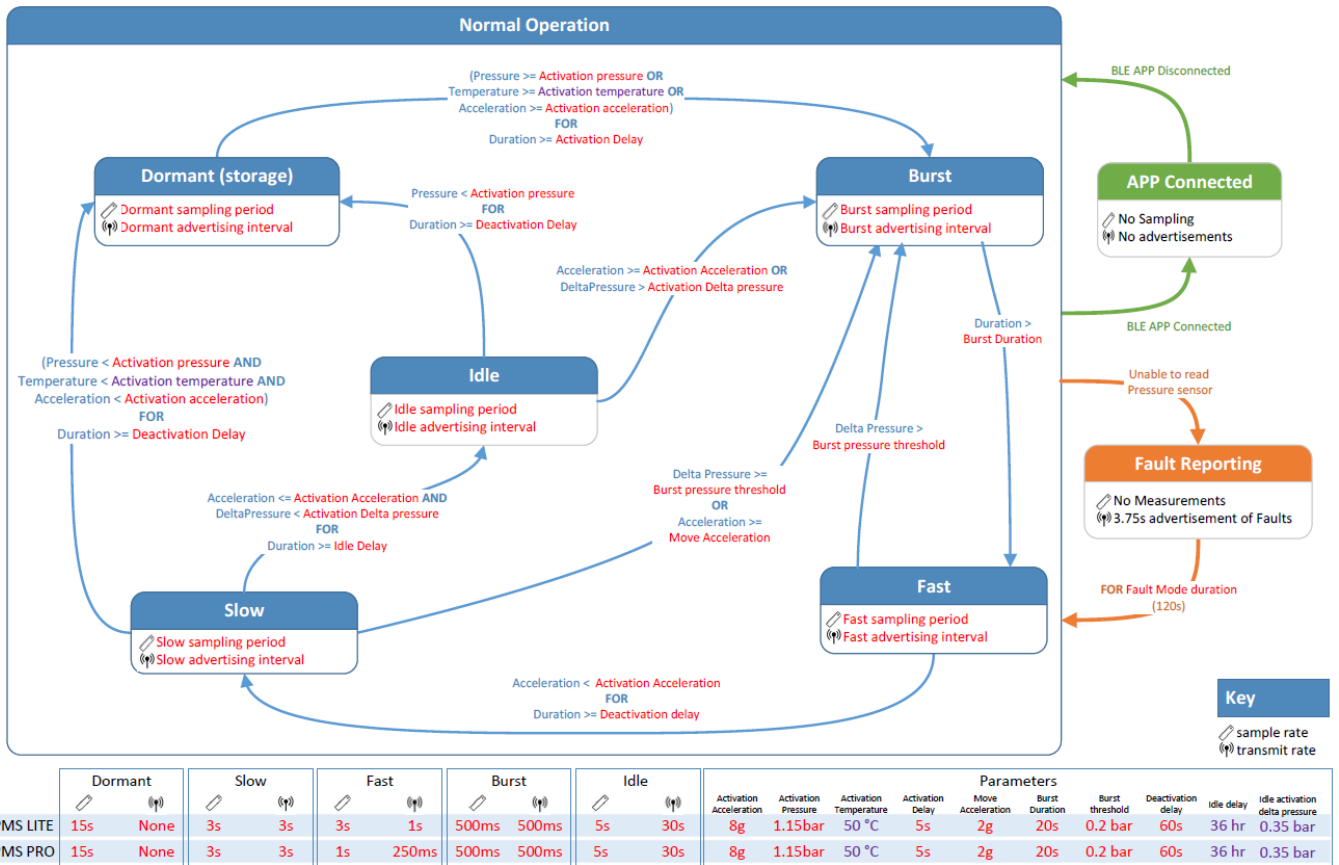

Figure 20 - IRTPMS v1.7 state diagram

8.3 1SYSTEM® ECUs

The 1SYSTEM® ECU Antennas are high sensitivity digital antennas capable of receiving datagrams from all types of 1SYSTEM® wheel sensors (standard TPMS and IRTPTMS). There is no need to reprogram anything when swapping between sensor types on the vehicle.

The distributed system architecture means only +12V, 0V, CANH & CANL connections are required for each ECU on the car, simplifying car wiring and removing a central TPMS ECU.

Advanced learning algorithms within the ECUs provide the fastest ever learning of wheel sensors fitted to the vehicle.

8.3.1 ECU Lite



Figure 21 - 1SYSTEM® ECU Lite

ECU Lite Spec	
bf1systems part no.	F1-100-1799-002
IP Rating	6K7
Operating Temperature Range	0 to 105°C 32 to 221°F
Weight	80g 2.83 ounce
Mating Connector Type	Molex MX150 Series
Mating Connector Manufacturer part no.	0334724801
Mating Connector (Female) Terminal Manufacturer part no.	0330122004
Mating Connector Cavity Plug Manufacturer part no.	0343450001
Mating Connector Backshell Manufacturer part no.	0349510811

Table 3 - ECU Lite Specification

8.3.1.1 ECU Lite Pinout

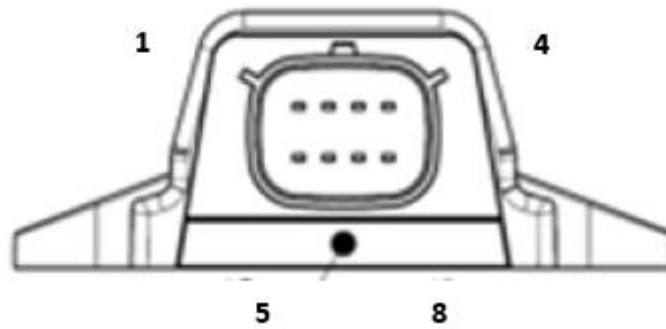

Figure 22 - ECU Lite Pinout

Each ECU is configured to its position using the link pin assignments for pins 2 and 6 shown in Table 4

Pin Number	Description
1	CAN H
2	LINK PIN 2
3	VBAT 12V
4	GND
5	CAN L
6	LINK PIN 6
7	LINK PIN 7
8	LINK PIN 8

Corner Position Assignment – Learning system		
Position	LINK PIN 2	LINK PIN 6
FL	NO CONNECT	NO CONNECT
FR	LINK PIN 8	NO CONNECT
RL	NO CONNECT	LINK PIN 7
RR	LINK PIN 8	LINK PIN 7

Table 4 - ECU Lite Pinout and assignment

8.3.2 ECU Pro

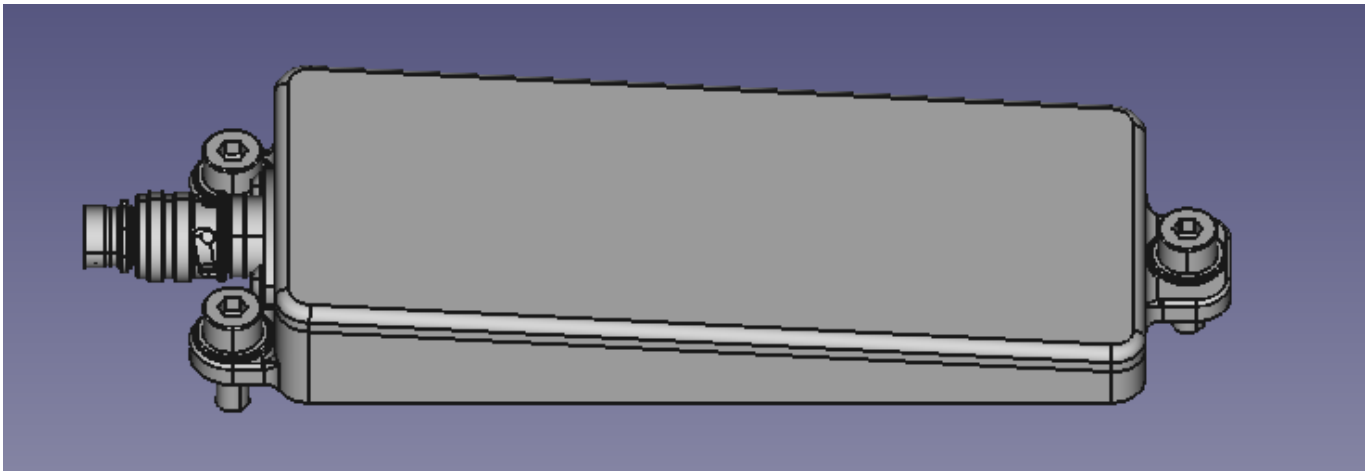

Figure 23 - 1SYSTEM® ECU Pro

ECU Pro Spec	
bf1systems part no.	F1-100-1799-003
IP Rating	6K7
Operating Temperature Range	0 to 105°C 32 to 221°F
Weight	55g 1.94 ounce
Mating Connector Type	Deutsch AS Micro XtraLITE HE 6 Way Connector
Mating Connector Manufacturer part no.	ASX602-06SN-HE-R
Mating Connector Socket Manufacturer part no.	605704
Mating Connector Cavity/Filler Plug Manufacturer part no.	600300-24

Table 5 - ECU Pro Specification

8.3.2.1 ECU Pro Pinout



Figure 24 - ECU Pro Pinout

Each ECU is configured to its position using the link pin assignments for pins 2 and 6 shown in Table 4

Pin Number	Description
1	CAN H
2	LINK PIN 2
3	VBAT 12V
4	GND
5	CAN L
6	LINK PIN 6

Table 6 - ECU Pro Pinout

8.3.3 ECU Corner or Position Assignment Pin Selection

ECU Position	LINK PIN 2	LINK PIN 6
FL	NC	NC
FR	To GND	NC
RL	NC	To GND
RR	To GND	To GND

Table 7 - ECU Pro Corner Pin Assignment for Learning system

ECU layout or architecture	ECU Position	LINK PIN 2	LINK PIN 6
1 Central ECU	-	NC	NC
1 Front and 1 Rear ECU	Front ECU	NC	NC
	Rear ECU	NC	To GND
1 Front and 2 Rear ECUs	Front ECU	NC	NC
	Rear Left ECU	NC	To GND
	Rear Right ECU	To GND	To GND
4 ECUs (oner per corner)	Front Left ECU	NC	NC
	Front Right ECU	To GND	NC
	Rear Left ECU	NC	To GND
	Rear Right ECU	To GND	To GND
1 Left and 1 Right ECU	Left ECU	NC	NC
	Right ECU	To GND	NC

Table 8 - ECU Pro Position Pin Assignment for Positioned system

NOTE: To use as a positioned system also requires changes to the ECU Characteristics, see section 18

9 Component Installation

9.1 General

9.1.1 Learning or Positioned 1SYSTEM® TPMS ?

It is important to consider which type of system is required before ordering 1SYSTEM® TPMS ECUs.

A Learning system is primarily used for Endurance / LMP / GT style of racing, where the wheels, and therefore sensors, can be mounted onto any corner of the vehicle. For these vehicles, typically there are numerous options for mounting an ECU at each corner.

A Positioned system is necessary when there are limited options to mount ECUs, such as open-wheel race cars, so up to 4 x ECUs can be used to achieve a functioning system. Please discuss with bf1systems engineers before ordering your ECUs.

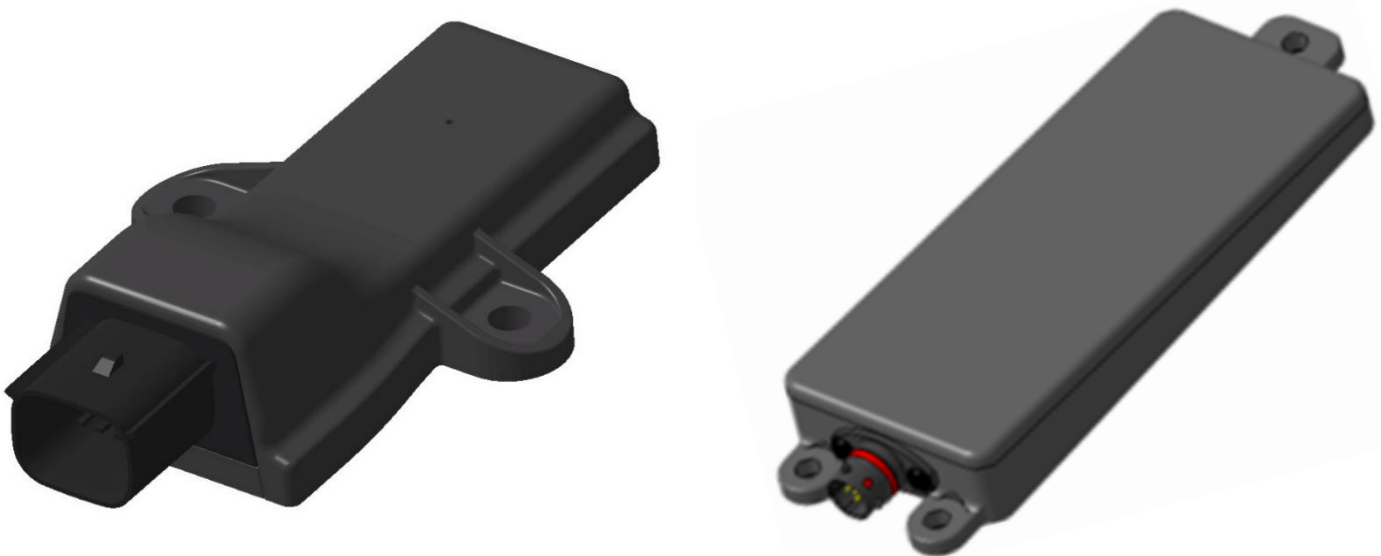

Figure 25 - Lite ECU (left) & Pro ECU (right)

9.1.2 Wiring

The wiring harness schematic for the TPMS can be found in Section 21 of this document.

Please note that if you are manufacturing the wiring harness, some basic rules should be observed:

- All CAN wiring must be a twisted pair
- It is recommended that the +12V and GND wiring to the TPMS ECU should be a twisted pair

9.2 Learning 1SYSTEM® TPMS Installation Guidance

With the Learning 1SYSTEM® TPMS, you will receive 4 x ECUs for fitment to your vehicle.

Each ECU must be mounted in the wheel arch area. The ECU receives wheel sensors when the car is stationary as well as when it is moving, to allow the system to recognise on which corner each wheel sensor is fitted as quickly as possible.

To ensure reliable reception and learning of the wheel sensors, the ECU must be mounted within the wheel arch area, either around the circumference of the wheel arch, or the inner surface adjacent to the wheel (e.g. on the side of the chassis). If the car has wheel arch liners, then it is possible for the ECU to be mounted to the back of the arch liner. However, if the arch liner is manufactured from carbon-fibre, then it may be necessary to create a window of either Kevlar or glass-fibre to prevent the signal to the ECU being reduced.

To ensure that the ECU learns the nearest sensor, it is important that the ECU does not have line-of-sight to another wheel, when mounted on the car. Therefore, shielding the ECU from other corners is important.

If mounting on a vehicle that has an open wheel arch, boot or engine compartment, the ECU should be mounted in an area that has shielding from the wheel on the opposite side, so not in open space.

9.2.1 Wheel Arch Mounting – Front Engine

Mounting front ECUs behind the front axle line would mean the engine is acting like a shield.

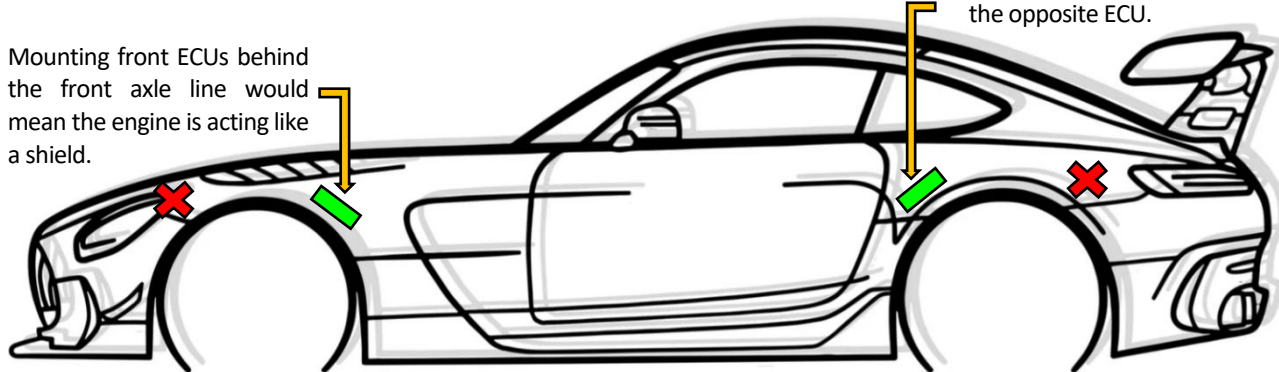

Mounting rear ECUs in front the rear axle line means the signal can't use the open boot space to reach the opposite ECU.

Usually exhaust systems prevent the ECUs being mounted any lower

9.2.2 Wheel Arch Mounting – Rear Engine

Mounting front ECUs behind the front axle line and low, means the signal can't use the open boot space to reach the opposite ECU.

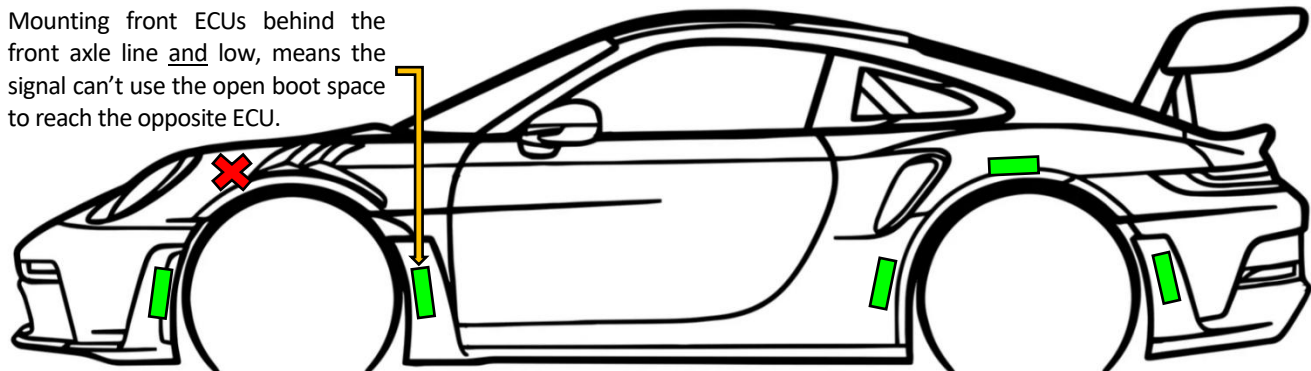

9.2.3 Wheel Arch Mounting – Mid Engine

Mounting front ECUs in front of the front axle line and low, would mean the radiators are acting like a shield.

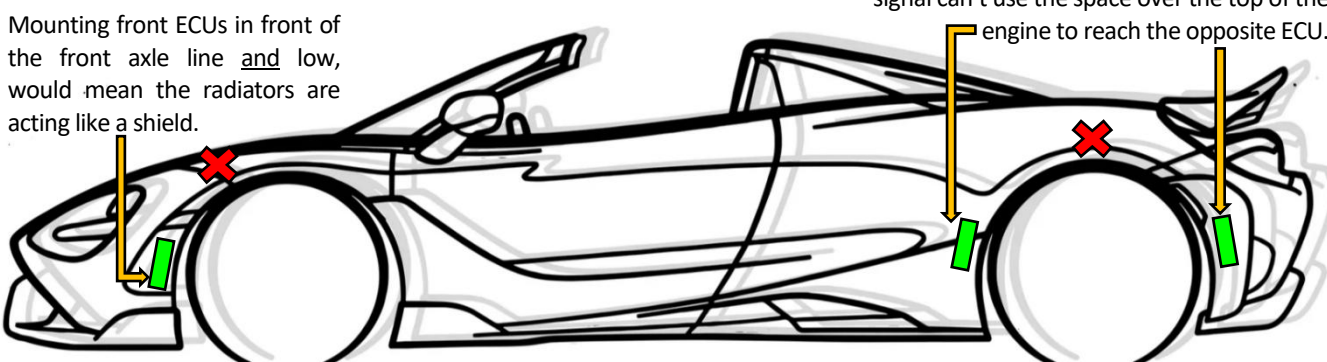

Mounting rear ECUs low means that the signal can't use the space over the top of the engine to reach the opposite ECU.

Figure 26 - Examples of ECU mounting positions

NOTE: Because 1SYSTEM® TPMS relies on using signal strength to determine the wheel mounted, the ECU position may need to be adjusted following analysis of the reception data in the logged data.

9.3 Positioned 1SYSTEM® TPMS Installation Guidance

With the Positioned 1SYSTEM® TPMS, up to 4 x ECUs can be configured and mounted on the vehicle.

Section 18 provides information of positions on the vehicle for the ECUs when different numbers of ECUs are used.

When the ECUs are installed on the vehicle, it is preferable not to mount behind carbon fibre or metal, which will attenuate the wheel sensor signal and prevent acceptable reception. If the ECU must be located behind such a material, then Kevlar or glass fibre windows can be placed around the ECU. This aspect of ECU mounting is not as critical as with a Learning installation, but it will help.

10 Learning System Operation

The 1SYSTEM® TPMS has the ability to automatically start transmitting data for wheel sensors mounted on the car when the system is powered.

The wheel sensors transmit advertisement data packets to advertise to the ECUs on the vehicle, which are received and used to detect which wheel sensor is fitted in each position.

A sensor will only be received by the ECUs on the car if the security settings (manufacturer ID, series ID and team ID), match in the ECU and also in the wheel sensor. Users are only able to change the team ID themselves using the 1SYSTEM® App. This security is to prevent teams from viewing each other's sensors.

Once the security settings allow a sensor to be received, an average of the signal strength (RSSI) from each sensor is calculated and the wheel sensor with the strongest signal is determined to be the closest to the ECU and therefore the correct wheel sensor for the corner, the ECU and wheel sensor will then lock onto this and the ECU will set the 'TPM1S_XX_WS_NOT_DETECTED' CAN signal to FALSE. If no wheel sensor is found or the wheel sensor closest cannot be determined, this will remain TRUE.

Once the wheel sensors have been detected, the TPMS CAN signals will be updated on the CAN bus so pressures and temperatures can be displayed.

When the vehicle starts moving, the rotation is determined by the wheel sensors and the transmission rate increases (exact transmit rate is dependent on the specification of sensor fitted). The sensors will transmit a moving status within the data packet.

Using the vehicle speed CAN input, the ECU will detect the car is moving, it will then confirm the wheel sensors for each corner using the signal strength as well as the moving signal transmitted and set the 'TPM1S_XX_WS_NOT_CONFIRMED' CAN signal to FALSE.

If the speed is not received by the ECU or the wheel sensor detected does not transmit the moving status, the 'TPM1S_XX_WS_NOT_CONFIRMED' signal will remain TRUE.

If the ECU had detected a wheel sensor that is not fitted to the car (possible if wheels are close by when the car is stationary) or if a wheel sensor stops transmitting, the ECU will wait 6 seconds and set both the 'TPM1S_XX_WS_NOT_DETECTED' and 'TPM1S_XX_WS_NOT_CONFIRMED' signals to TRUE.

The ECU will continue to check for a replacement sensor. For this reason, it is necessary to setup the ECU RSSI limit from testing, so the ECU is not able to detect and confirm a wheel sensor from another corner of the car. The RSSI limits can be set within the ECU configuration using the 1SYSTEM® App, see section 0 for test procedures to determine the correct value.

11 1SYSTEM® Application Software

The 1SYSTEM® PC application is delivered alongside bf1systems TPMS and is allows the user to:

- Claim wheel sensors
- Apply security settings to wheel sensors and ECUs
- Configure CAN Tx & Rx message IDs
(will be available as part of coming ECU Firmware version 2.16 and 1SYSTEM® App version 1.5 onwards).
- Configure the levels for the puncture detect warnings
- Monitor live pressure and temperature data

If you have not received the 1SYSTEM® application, please use the link in section 3 for the latest download.

11.1 Installation and License Update

To install the application, see Section 3.

11.2 App settings

Some of the setting within the app can be set up to suit your requirements.

Following any changes, the settings will need to be saved.



Figure 27 - Settings page

11.2.1 Offline sensor timeout

The offline sensor timeout is used in conjunction with the filtering on the All Sensor page and determines when a sensor is filtered from the display

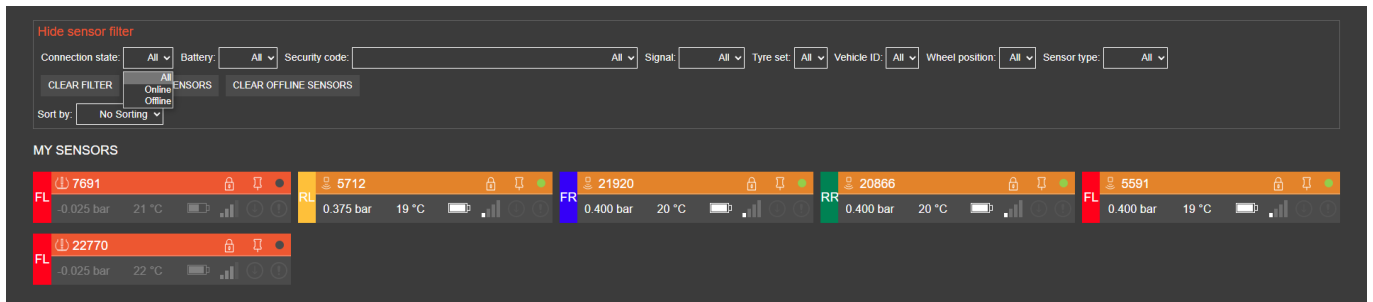

Figure 28 - Offline filter set on All page

11.2.2 Sensor reference pressure

Sets the atmospheric pressure offset for sensors received over 2.4GHz by the PC displayed on the All, Near and Nearest pages.

Does not affect the sensors shown on the CAR page.

11.2.3 CAN settings

Sets the parameters for CAN comms between the PC and ECUs

11.2.4 XCP broadcast ID

Used by the 1SYSTEM app to read the CAN IDs programmed into the ECU so comms can be maintained if the CAN IDs of the ECU have been altered.

11.2.5 Temperature unit

Changes the temperature unit displayed between °C and °F.

11.2.6 Pressure unit

Changes the pressure unit displayed between Bar, mbar and PSI.

11.2.7 Car type

Changes the car pictured on the Car page between a closed and open wheeled representation.

11.2.8 Sensor representation

Displays the sensor serial number in either decimal serial number or the hexadecimal MAC address.

11.2.9 Manual positioning

When enabled, shows the sensor corner designation.

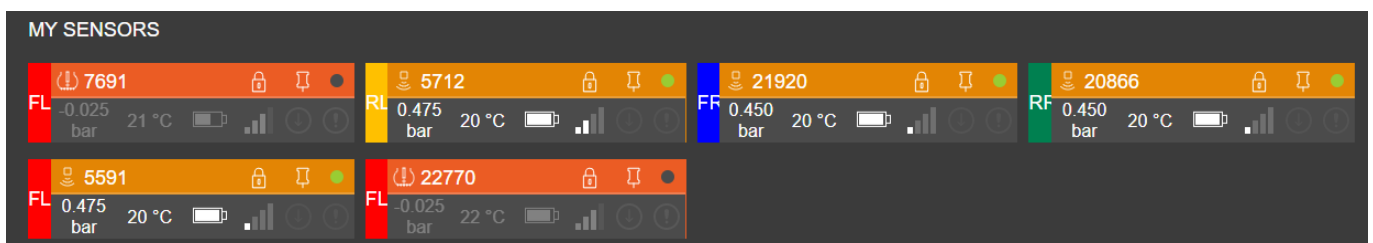

11.2.10 Show compensated pressure

When enabled, the pressure compensated to the Sensor reference temperature will be displayed for the sensor.

NOTE: The ECU reported temperature compensated pressure uses a fixed value of 25°C.

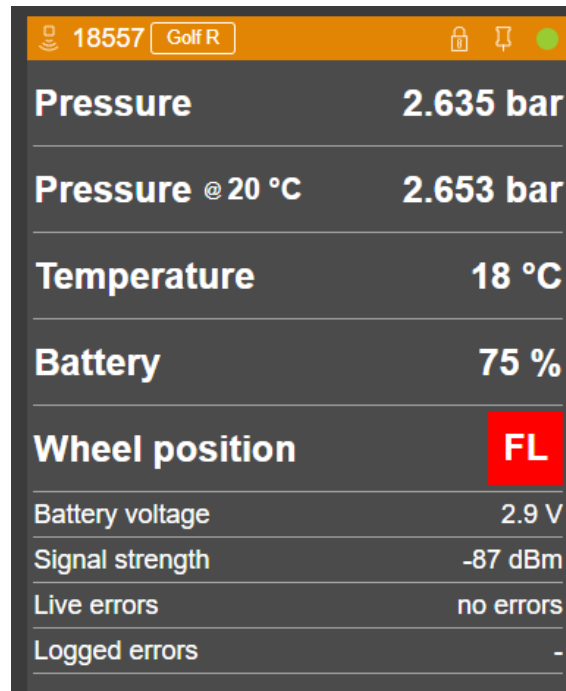

Figure 29 - Temperature compensated pressure displayed

11.2.11 Theme

Changing the theme from default to high contrast will change the background colours make the screen easier to read in certain conditions such as bright sunlight.

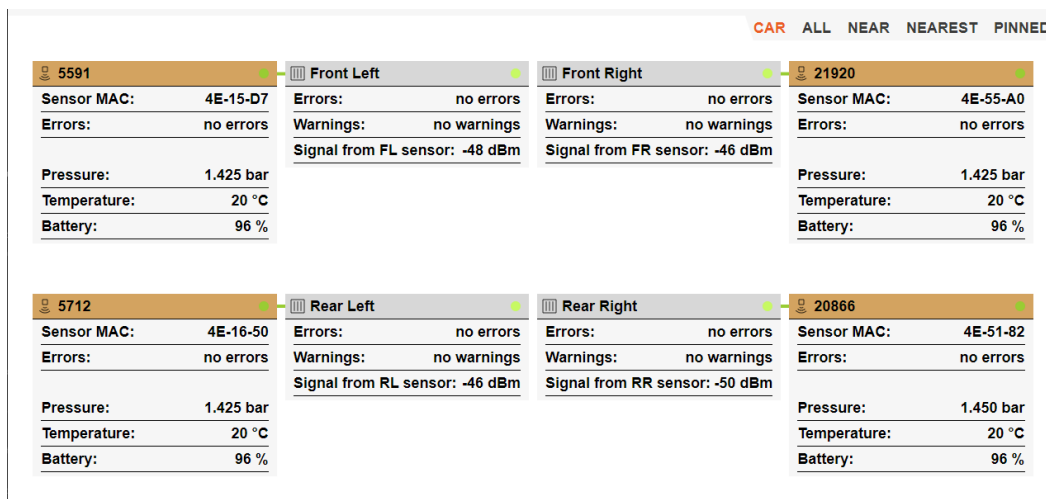

Figure 30 - High contrast Theme

11.2.12 Start page

Selects the page the 1SYSTEM app displays when opened.

11.2.13 SRW Mode

Selects between the bf1systems Track Link dongle or an internal Bluetooth (internal includes the dongle such as the TP Link).

For Track Link dongle see section 27.

11.3 Car Page

The user is automatically taken to 'Car' page when the application is launched. This page contains licence information, the version number, and status of SRW (short range wireless connection) and CAN connection.

The status of ECUs and any detected wheel sensors will also be displayed.

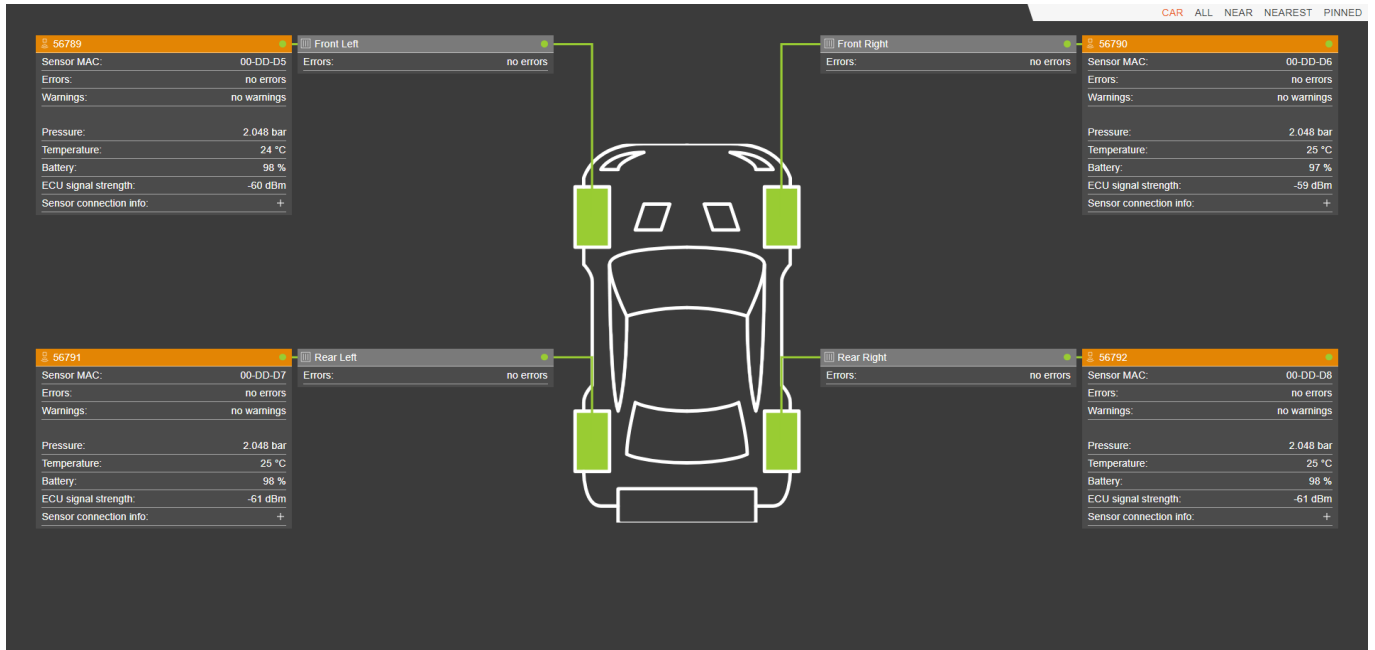

Figure 31 - Car page with a valid licence and connections

11.4 Connected ECUs

The car page shows an overview for each ECU connected across the top of the page.



Figure 32 - Front left ECU overview

11.4.1 Live Connection

The flashing green lamp in the top right shows a valid connection.

11.4.2 Firmware Version

A circled arrow will indicate if a firmware update is available. See firmware update Section 11.9.

If the firmware is up to date, the version programmed can be seen when the detailed ECU view is selected, see section 0

11.4.3 Errors

Live hardware errors are shown when present and the tyre for the corner affected will change colour to orange



Figure 33 - Hardware errors

To check the Errors, see section 0

11.4.4 Pressure Warnings

Live pressure warnings are shown when present and the tyre for the corner affected will change colour to orange or red

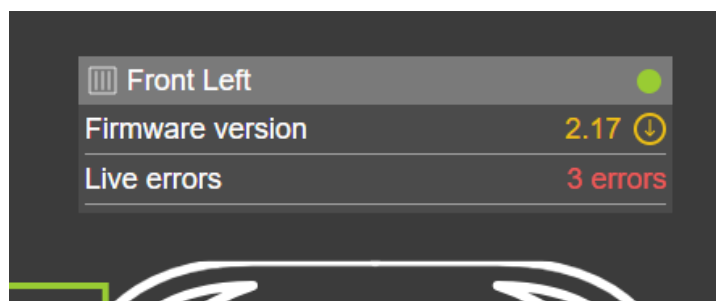

Figure 34 - Live pressure warnings

To check the Warnings, see section 0

11.5 ECU Detail View

A detailed view of each ECU can be achieved by clicking on the grey position indicator block, this will take you to the Characteristics page.

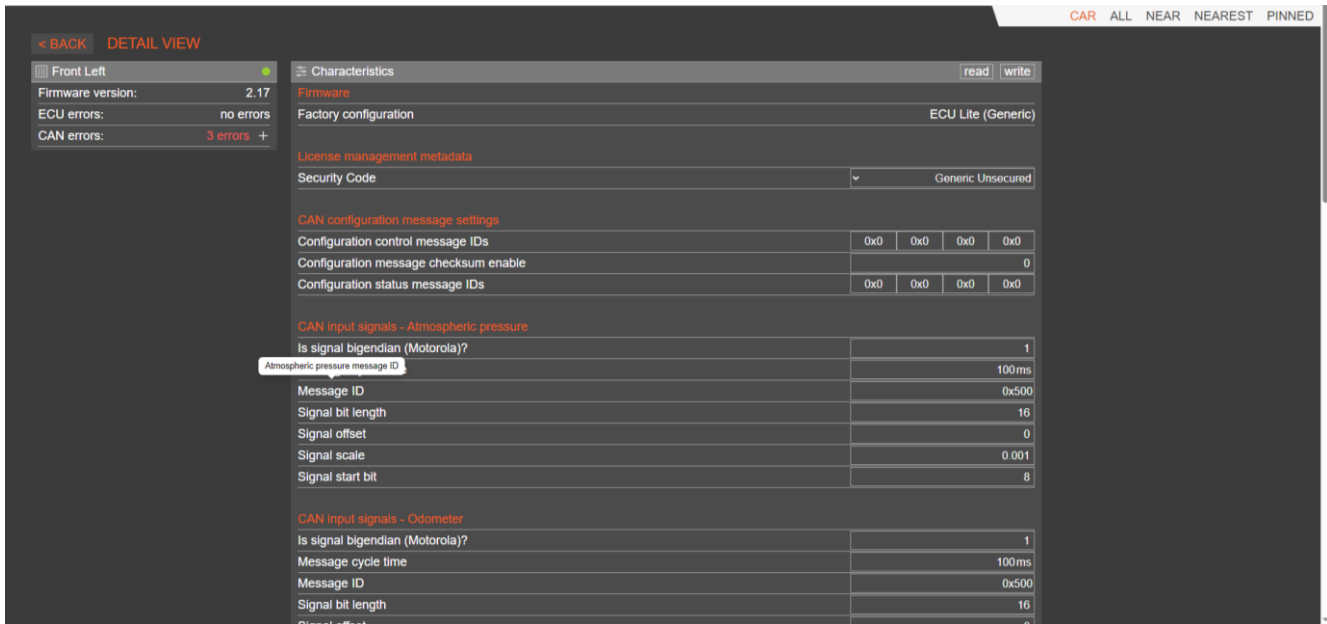

Figure 35 - ECU Characteristics page

The page displays the Characteristics of the selected ECU and enables access to the errors and warnings.

Hovering over the characteristic titles will display a brief description.

11.5.1 Warnings and Errors

A list of any live errors or warning can be viewed by clicking on the +

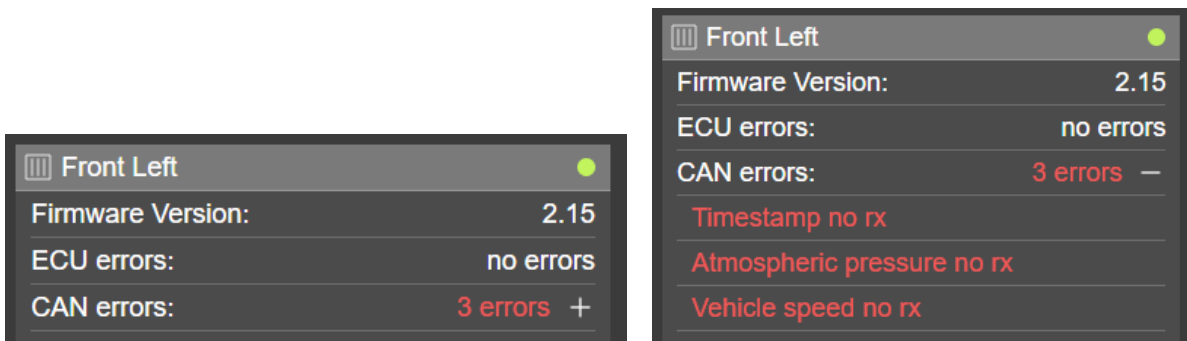

Figure 36 - Live errors

11.6 ECU Characteristics – Core Licence

11.6.1 Read, Write and Factory Reset

Click on the grey bar for the required ECU, the characteristics page will open, the software will automatically read the characteristics from the ECU.

A read button is also available to re-read from the ECUs.

Any changes made to the setup can be written to the ECUs using the write button.



Figure 37 - Characteristics Read and Write buttons

11.6.2 Firmware

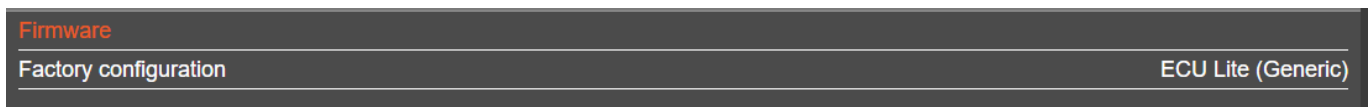

Figure 38 - Factory configuration

Factory configuration - Identifies the ECU type and customer.

11.6.3 Warnings

Warnings	
Flat tyre warning threshold	700 mbar
High tyre temperature warning threshold	125 °C
IR sensor high temperature warning threshold	150 °C
Low tyre pressure hard warning threshold	400 mbar
Low tyre pressure soft warning threshold	250 mbar
Rapid gas loss warning threshold	280 mbar/min
Wheel sensor low battery threshold	10%

Figure 39 - Tyre Warning Limits

Flat tyre warning threshold (gauge) - The lowest acceptable pressure that can be present in a tyre before the ECU transmitted signal 'TPM1S_XX_WS_UNDER_PRESS_HARD_WRN' is triggered. This absolute pressure limit is an actual tyre pressure and not a compensated one.

High tyre temperature warning threshold - This is the maximum acceptable temperature that can be present in a tyre before the ECU transmitted signal 'TPM1S_XX_WS_HIGH_TEMP_WRN' is triggered.

IR sensor high temperature warning threshold - The maximum acceptable temperature for the tyre carcass pixel points (not yet implemented).

Low tyre pressure hard warning threshold (delta) - This is the maximum amount of pressure deviation from the normalised pressure before the ECU transmitted signal 'TPM1S_XX_WS_UNDER_PRESS_HARD_WRN' is triggered.

Low tyre pressure soft warning threshold (delta) - This is the maximum amount of pressure deviation from the normalised pressure before the ECU transmitted signal 'TPM1S_XX_WS_UNDER_PRESS_SOFT_WRN' is triggered.

Rapid gas loss warning threshold (delta) - This is a parameter that the system can use to determine whether the tyre is losing pressure greater than a pre-determined rate per minute. If the calculated pressure loss rate is greater than the set value, then the ECU transmitted signal 'TPM1S_XX_WS_UNDER_PRESS_HARD_WRN' will triggered, regardless of current pressure value.

Wheel sensor low battery threshold (%) - The minimum remaining battery life set for the detected sensor

11.6.4 Wheel detection and confirmation

Wheel detection and confirmation				
IR wheel sensor detection threshold	-70 dBm			
Monitored wheel position setups	AUTO ▾	AUTO ▾	AUTO ▾	AUTO ▾
TPMS wheel sensor detection threshold	-60 dBm			

IR wheel sensor detection threshold - Sets the minimum received signal strength allowed by the ECU to connect to an IR wheel sensor. This parameter will be used to stop wheels from other corners of the vehicle being detected by the ECU.

TPMS wheel sensor detection threshold - Sets the minimum received signal strength allowed by the ECU to connect to a **non IR** wheel sensor. This parameter will be used to stop wheels from other corners of the vehicle being detected by the ECU.

11.6.5 Licence management meta-data

License management meta-data	
Security Code	Generic Unsecured ▾

Figure 40 - Licence

Security Code - The security code for the ECU. Wheel sensors used with the ECU must have matching security codes for the ECU to transmit data.

11.7 ECU Characteristics - Core Plus Licence

NOTE: When updating parameters that have 4 boxes shown below, 1 for each ECU, the order is as follows:

FL	FR	RL	RR
0x700	0x700	0x700	0x700

11.7.1 Read, write and factory reset

When the page is opened, the software will automatically read the characteristics from the ECU. A read button is also available to re-read from the ECUs.

Any changes made to the setup can be written to the ECUs using the write button.

If unknown changes have been made to an ECU, the default factory configuration can be written using the *factory reset* button.



Figure 41 - Characteristics Read, Write and Factory Reset buttons

11.7.2 Firmware

Firmware	
Factory configuration	ECU Lite (Generic)
Full version	2.21.8265297

Figure 42 - Factory configuration

Factory configuration - Identifies the ECU type and customer.

Full version – displays the full firmware version number

11.7.3 Licence management meta-data

Licence management meta-data	
Security Code	Generic Unsecured ▾

Figure 43 - Licence

Security Code - The security code for the ECU. Wheel sensors used with the ECU must have matching security codes for the ECU to transmit data.

11.7.4 CAN configuration message settings

CAN configuration message settings				
Configuration control message IDs	0x0	0x0	0x0	0x0
Configuration message checksum enable	0			
Configuration status message IDs	0x0	0x0	0x0	0x0

The configuration settings are used in some specific race series, if populated they should not be changed.

11.7.5 CAN Receive message settings

CAN input signals - Atmospheric pressure	
Is signal bigendian (Motorola)?	1
Message cycle time	100 ms
Message ID	0x500
Signal bit length	16
Signal offset	0
Signal scale	0.001
Signal start bit	8

Figure 44 - CAN Settings - Atmospheric pressure

CAN input signals - Odometer	
Is signal bigendian (Motorola)?	1
Message cycle time	100 ms
Message ID	0x500
Signal bit length	16
Signal offset	0
Signal scale	2
Signal start bit	40

Figure 45 - CAN Settings - Odometer

CAN input signals - Vehicle speed	
Is signal bigendian (Motorola)?	1
Message cycle time	100 ms
Message ID	0x500
Signal bit length	16
Signal offset	0
Signal scale	0.1
Signal start bit	24

Figure 46 - CAN Settings - Vehicle speed

CAN input signals - P Ref Set	
Message cycle time	100 ms
Message ID	1280
Signal start bit	51

Figure 47 - P Ref manual set

CAN input signals - These CAN message settings enable the user to change the CAN IDs of the received data from the vehicle, this data includes the Rx atmospheric pressure and the Rx vehicle speed, the Rx Odometer and P Ref reset.

When changes have been made to the Rx CAN ID, the ECU will require a power cycle to confirm the update.

Note: the settings shown above are correct for the STD DBC supplied by bf1systems

The P Ref Set CAN input can be used to manually set the reference pressure used for the pressure warnings, activation is taken from the rising edge of the signal, we suggest the signal is set high for a minimum of 100mS.

11.7.5.1.1 FiA, IMSA and DTM race series CAN receive

For FiA, IMSA and DTM race series, the atmospheric pressure CAN settings are pre-determined by the series authority so are not visible for modification within the app.

Details of the CAN IDs for the atmospheric pressure, race series ID and Authorisation seed data can be found in the CAN DBC available on the support web page or on request from 1SYSTEM@BF1SYSTEMS.COM email.

Each series uses their own specific authorisation seed, the series in which the car is being run must be transmitted to all TPMS ECUs so the seed is decoded correctly.

For other race series, this CAN input will not be required and is disabled by default.

NOTE: Firmware prior to v2.22 used different firmwares for each race series, v2.22 will detect the series using the series ID CAN signal and decode accordingly.

11.7.6 CAN Transmit message settings

CAN message settings				
Baudrate	1MBPS ▾			
Diagnostic message IDs	0x714	0x715	0x716	0x717
ECU info message IDs	0x704	0x705	0x706	0x707
Wheel sensor data message IDs	0x600	0x601	0x602	0x603
Wheel sensor info message IDs	0x604	0x605	0x606	0x607
Wheel sensor info2 message IDs	0x626	0x627	0x627	0x629
Wheel sensor IR data message IDs	0x608	0x609	0x60a	0x60b

Figure 48 - CAN Transmit settings

Baudrate - Sets the CAN baudrate

Diagnostic message IDs - Sets IDs to transmit TPMS diagnostic data (TPM1S_XX_DIAG)

ECU info message IDs - Sets IDs to transmit TPMS ECU data (TPM1S_XX_ECU_INFO)

Wheel sensor data message IDs - Sets IDs to transmit TPMS wheel sensor data (TPM1S_XX_WS_DATA)

Wheel sensor info message IDs - Sets IDs to transmit TPMS wheel sensor data (TPM1S_XX_WS_INFO)

Wheel sensor info2 message IDs - Sets IDs to transmit TPMS wheel sensor data (TPM1S_XX_WS_INFO_2)

Wheel sensor IR data message IDs - Sets IDs to transmit TPMS wheel sensor IR temperature data (TPM1S_XX_WS_IR_DATA)

CAN XCP message settings				
XCP broadcast message ID	0x0			
XCP command message IDs	0x708	0x709	0x70a	0x70b
XCP response message IDs	0x70c	0x70d	0x70e	0x70f

Figure 49 - CAN XCP message settings

CAN XCP broadcast message ID - Not currently used

XCP command message IDs - Used for communications from the PC based 1SYSTEM® software and each ECU. Do not change.

XCP response message IDs - Used to respond from each ECU to from the PC based 1SYSTEM® software. Do not change

11.7.7 Diagnostics

Diagnostics

Signal all rx packets on diagnostic Mux0

Signal all Rx packets on diagnostic Mux0 - The diagnostic message is used to determine the reception for the ECU. When enabled, the data from any sensor received by the ECU, stationary or moving, will be transmitted asynchronously onto the CAN bus.

The ECU has 4 buffers for the received wheel sensors, when set to 0, the data is filtered to transmit as multiplex signals updating each buffer as the wheel sensor is received, see Figure 50.

Name	Message	Multiplexing/Group
TPM1S_FL_DIAG_MUX_ID	TPM1S_FL_DIAG	Multiplexor
TPM1S_FL_DIAG_ADV_POSN_1	TPM1S_FL_DIAG	TPM1S_FL_DIAG_MUX_ID = 0x0
TPM1S_FL_DIAG_ADV_POSN_2	TPM1S_FL_DIAG	TPM1S_FL_DIAG_MUX_ID = 0x1
TPM1S_FL_DIAG_ADV_POSN_3	TPM1S_FL_DIAG	TPM1S_FL_DIAG_MUX_ID = 0x2
TPM1S_FL_DIAG_ADV_POSN_4	TPM1S_FL_DIAG	TPM1S_FL_DIAG_MUX_ID = 0x3
TPM1S_FL_DIAG_VEH_SPEED	TPM1S_FL_DIAG	TPM1S_FL_DIAG_MUX_ID = 0x8
TPM1S_FL_DIAG_ADV_ID_1	TPM1S_FL_DIAG	TPM1S_FL_DIAG_MUX_ID = 0x0
TPM1S_FL_DIAG_ADV_ID_2	TPM1S_FL_DIAG	TPM1S_FL_DIAG_MUX_ID = 0x1
TPM1S_FL_DIAG_ADV_ID_3	TPM1S_FL_DIAG	TPM1S_FL_DIAG_MUX_ID = 0x2
TPM1S_FL_DIAG_ADV_ID_4	TPM1S_FL_DIAG	TPM1S_FL_DIAG_MUX_ID = 0x3
TPM1S_FL_DIAG_VEH_ATMOS_P	TPM1S_FL_DIAG	TPM1S_FL_DIAG_MUX_ID = 0x8
TPM1S_FL_DIAG_ECU_HEALTH	TPM1S_FL_DIAG	TPM1S_FL_DIAG_MUX_ID = 0x9
TPM1S_FL_DIAG_ADV_RSSI_1	TPM1S_FL_DIAG	TPM1S_FL_DIAG_MUX_ID = 0x0
TPM1S_FL_DIAG_ADV_RSSI_2	TPM1S_FL_DIAG	TPM1S_FL_DIAG_MUX_ID = 0x1
TPM1S_FL_DIAG_ADV_RSSI_3	TPM1S_FL_DIAG	TPM1S_FL_DIAG_MUX_ID = 0x2
TPM1S_FL_DIAG_ADV_RSSI_4	TPM1S_FL_DIAG	TPM1S_FL_DIAG_MUX_ID = 0x3
TPM1S_FL_DIAG_ECU_CORE_TEMP	TPM1S_FL_DIAG	TPM1S_FL_DIAG_MUX_ID = 0x9
TPM1S_FL_DIAG_VEH_ODOMETER	TPM1S_FL_DIAG	TPM1S_FL_DIAG_MUX_ID = 0x8
TPM1S_FL_DIAG_VEH_MOVING	TPM1S_FL_DIAG	TPM1S_FL_DIAG_MUX_ID = 0x8

Figure 50 - Multiplex diagnostic message - Mux0 set to 0

By changing this setting to 1, all wheel sensor data will be sent in single signals as received by the ECU, this should only be used to reduce the number of logged channels and requires post processing to understand the data.

Name	Message	Multiplexing/Group
TPM1S_FL_DIAG_MUX_ID	TPM1S_FL_DIAG	Multiplexor
TPM1S_FL_DIAG_ADV_POSN_1	TPM1S_FL_DIAG	TPM1S_FL_DIAG_MUX_ID = 0x0
TPM1S_FL_DIAG_VEH_SPEED	TPM1S_FL_DIAG	TPM1S_FL_DIAG_MUX_ID = 0x8
TPM1S_FL_DIAG_ADV_ID_1	TPM1S_FL_DIAG	TPM1S_FL_DIAG_MUX_ID = 0x0
TPM1S_FL_DIAG_VEH_ATMOS_P	TPM1S_FL_DIAG	TPM1S_FL_DIAG_MUX_ID = 0x8
TPM1S_FL_DIAG_ECU_HEALTH	TPM1S_FL_DIAG	TPM1S_FL_DIAG_MUX_ID = 0x9
TPM1S_FL_DIAG_ADV_RSSI_1	TPM1S_FL_DIAG	TPM1S_FL_DIAG_MUX_ID = 0x0
TPM1S_FL_DIAG_ECU_CORE_TEMP	TPM1S_FL_DIAG	TPM1S_FL_DIAG_MUX_ID = 0x9
TPM1S_FL_DIAG_VEH_ODOMETER	TPM1S_FL_DIAG	TPM1S_FL_DIAG_MUX_ID = 0x8
TPM1S_FL_DIAG_VEH_MOVING	TPM1S_FL_DIAG	TPM1S_FL_DIAG_MUX_ID = 0x8

Figure 51 - Multiplex diagnostic message - Mux0 set to 1

Where possible it is recommended to leave this set to 0, this makes analysis easier due to the use of the separate sensor buffers.

When the reception has been setup on the car and working correctly, the user can choose to disable the diagnostic message.

If reception problems are seen during use, bf1systems will require a log of the advert data to assess the RF performance.

NOTE: For positioned systems, the diagnostic data is always transmitted as shown in setting MUX0 = 1 (even if set to 0)

11.7.8 General

General	
Vehicle ID	0

Vehicle ID - An optional numerical identifier for the vehicle to enable teams running more than one car. When set, the sensors will also need to be updated to the same vehicle ID to be received by the ECU.

11.7.9 License management

License management	
Factory configuration code	F1-100-1799-002

Factory configuration code - ECU part number

11.7.10 Warning limits

Warnings	
Flat tyre warning threshold	700 mbar
High tyre temperature warning threshold	125 °C
IR sensor high temperature warning threshold	150 °C
Low tyre pressure hard warning threshold	400 mbar
Low tyre pressure soft warning threshold	250 mbar
Rapid gas loss warning threshold	280 mbar/min
Wheel sensor low battery threshold	10 %

Figure 52 - Tyre Warning Limits

Flat tyre warning threshold (gauge) - The lowest acceptable pressure that can be present in a tyre before the ECU transmitted signal 'TPM1S_XX_WS_UNDER_PRESS_HARD_WRN' is triggered. This absolute pressure limit is an actual tyre pressure and not a compensated one.

High tyre temperature warning threshold - This is the maximum acceptable temperature that can be present in a tyre before the ECU transmitted signal 'TPM1S_XX_WS_HIGH_TEMP_WRN' is triggered.

IR sensor high temperature warning threshold - The maximum acceptable temperature for the tyre carcass pixel points (not yet implemented).

Low tyre pressure hard warning threshold (delta) - This is the maximum amount of pressure deviation from the normalised pressure before the ECU transmitted signal 'TPM1S_XX_WS_UNDER_PRESS_HARD_WRN' is triggered.

Low tyre pressure soft warning threshold (delta) - This is the maximum amount of pressure deviation from the normalised pressure before the ECU transmitted signal 'TPM1S_XX_WS_UNDER_PRESS_SOFT_WRN' is triggered.

Rapid gas loss warning threshold (delta) - This is a parameter that the system can use to determine whether the tyre is losing pressure greater than a pre-determined rate per minute. If the calculated pressure loss rate is greater than the set value, then the ECU transmitted signal 'TPM1S_XX_WS_UNDER_PRESS_HARD_WRN' will triggered, regardless of current pressure value.

Wheel sensor low battery threshold (%) - The minimum remaining battery life set for the detected sensor

11.7.11 Wheel detection and confirmation

Wheel detection and confirmation				
Duplicate wheel sensor detection mode	ENABLE ▾			
Missing ECU detection mode	ONE ▾			
Missing ECU proxy configuration	AXLE ▾			
Monitored wheel position setups	AU ▾	AU ▾	AU ▾	AU ▾
TPMS wheel sensor detection threshold	-60 dBm			
Vehicle moving speed threshold	35 kph			
Vehicle moving time threshold	8 s			
Vehicle stationary time threshold	2 s			
Wheel sensor movement threshold	0 g			
Wheel sensor timeout threshold	80 s			

Figure 53 - Detection and Positioning Settings

Duplicate wheel sensor detection mode – See section 0

NOTE: For learning systems only, not to be used for positioned systems

Missing ECU detection mode and proxy configuration – See section 0

IR wheel sensor detection threshold - Sets the minimum received signal strength allowed by the ECU to connect to an IR wheel sensor. This parameter will be used to stop wheels from other corners of the vehicle being detected by the ECU. See 0

Monitored wheel position setups - See section 18

TPMS wheel sensor detection threshold - Sets the minimum received signal strength allowed by the ECU to connect to a **non IR** wheel sensor. This parameter will be used to stop wheels from other corners of the vehicle being detected by the ECU.

Vehicle moving speed threshold (kph) - The minimum vehicle speed needed for the ECU to enter moving mode.

Vehicle moving time threshold (secs) - The amount of time that the car must be in moving mode before the ECU can confirm the detected sensors are correctly positioned.

Vehicle stationary time threshold (secs) - The amount of time that the car must be stationary before new wheels will be accepted by the system.

Wheel Sensor moving threshold - Force used by the sensor to determine it has transitioned to a moving state.

Wheel Sensor timeout - Time for ECU to set timeout pressure value for a detected sensor that is no longer being received.

11.8 Duplicate wheel and missing ECU detection (Robustness and Resilience)

The Duplicate wheel sensor detection, Missing ECU detection mode and Proxy configuration are new features introduced in firmware v2.21 and greater, it is also referred to as Robustness and Resilience (R&R).

11.8.1 Robustness

Ideal for cars where it is not possible to place the ECUs in positions that display a good signal strength separation between the sensors fitted to the car.

When enabled, each ECU communicates with the other ECUs using the TPM1S_XX_WS_INFO messages, it must be ensured that these messages are on the same CAN bus or are gatewayed between the busses the ECUs are connected to. Using this data, the ECUs can determine which ECU has detected which sensor and not allow 2 ECUs to detect the same sensor.

When enabled, the RSSI thresholds for both TPMS and I RTPMS sensors will be set to -90dBm but the previous user configured values will still be shown so if the feature is disabled, the thresholds will be returned to those set previously.

11.8.2 Resilience

When enabled (one), and setup with the Missing ECU proxy configuration, an ECU will act as a proxy for a second ECU should a single ECU become non responsive following an incident on track.

The proxy ECU can be set to transmit the wheel sensor data for the sensor on the same axle or same side of the car. For the best results, this can be determined using the Diag_RSSI data from each ECU, fig xxx shows the signal strengths of all sensors received by a single ECU, in this case the for the FL ECU, the FR sensor is received stronger than the RL so the proxy ECU should be set as 'AXLE'.

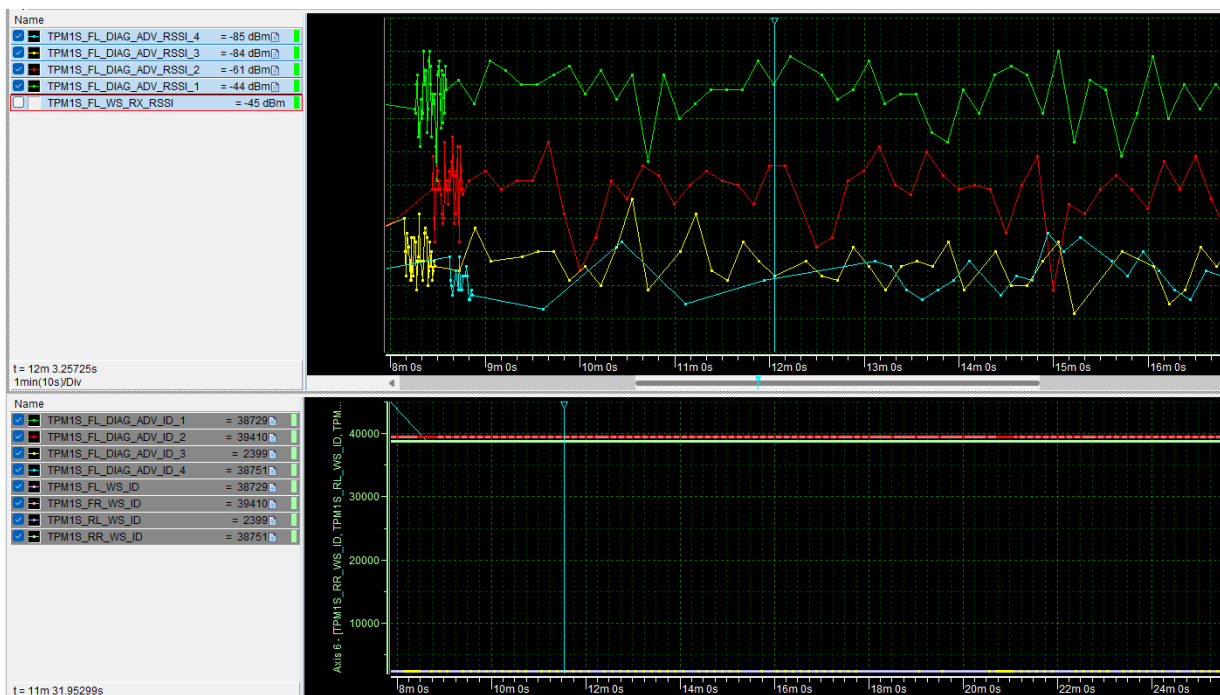

Figure 54 - Proxy ECU position selection

To use this feature, the Duplicate wheel sensor detection will be enabled so the ECU can transmit the data from a sensor that is not detected or monitored by another ECU (the 'Duplicate wheel sensor detection mode' will show as disabled if it has not been changed by the user).

An additional CAN signal (TPM1S_XX_WS_PROXY_ECU) has been added to the TPM1S_XX_WS_INFO messages which is set to 1 if the sensor data is being transmitted by a proxy ECU.

11.9 ECU Firmware update

An indication to show if the ECU firmware is up to date is displayed in the ECU overview on the CAR page.

If a newer version of firmware is available, a circled arrow will show next to the current firmware version.

Firmware updates will be released with new versions of the 1SYSTEM® app, it will not be possible to update from a separate file.

Select the detail view for the ECU that requires the firmware update.

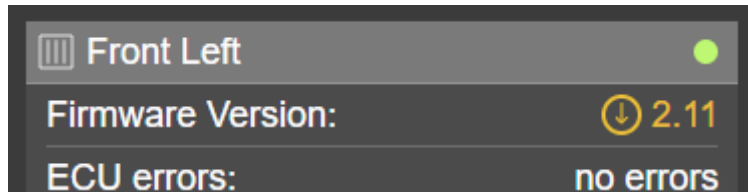

Figure 55 - Firmware version

Click on the circle or the firmware version to open the update page

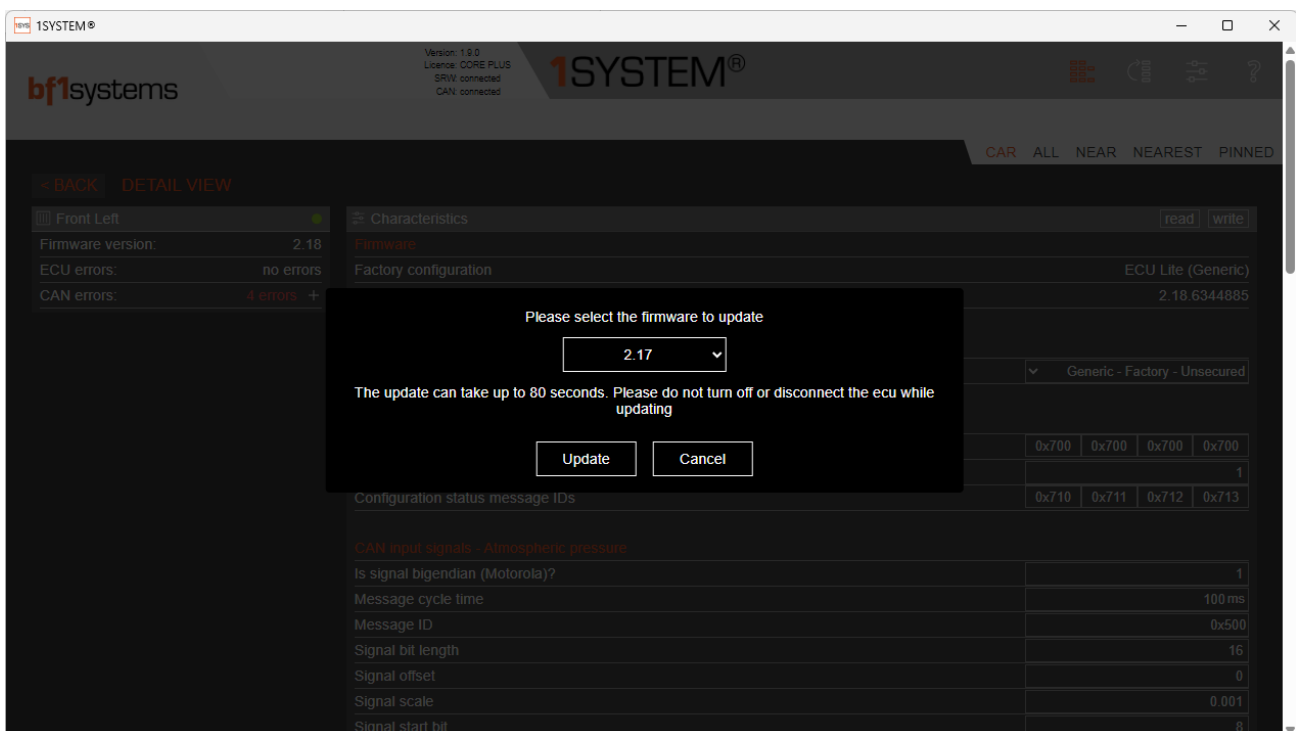

Figure 56 - Firmware update selection

It is possible to go back in firmware versions by selecting an older version from the drop-down list.

To install the firmware, click on the update button, the page will display the progress of the update

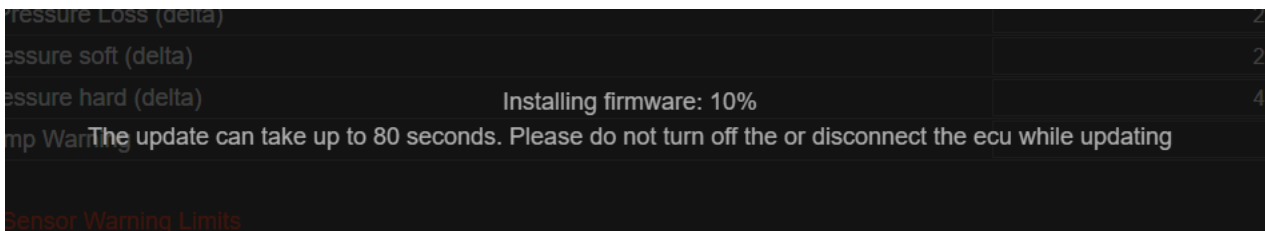

Figure 57 - Firmware update progress

Do not disconnect during the update and ensure vehicle battery is good.

The page will indicate when the update has completed.

11.10 Wheel Sensor Detected by the ECU

The car page shows an overview for the wheel sensor detected by each ECU.

Live Connection - The flashing green lamp in the top right shows a valid connection.

21931	
Sensor MAC	4E-55-AB
Errors	no errors
Warnings	no warnings
Pressure	1.437 bar
Temperature	22 °C
Battery	75 %
ECU signal strength	-32 dBm
Sensor connection info	—
Rx timeout	Sensor received
Rx counter	22
Confirmed status	Not confirmed
Detection status	Detected

Figure 58 - Wheel sensor overview

Sensor ID - The sensor ID is shown in both hexadecimal and decimal format. The decimal value is a conversion of the last two octets.

(hex) FC B8 = 64696 (dec)

This decimal value is laser marked on sensor housings

The full hexadecimal MAC address is laser marked on the sensor housing.

Sensor ID number – depending on the configured setting for the application, the serial number representation will be shown in the orange bar and the other shown in the next line below.

63282	BE-FC-B8
Sensor MAC: BE-F7-32	Sensor ID: 64696

Figure 59 - Sensor ID representation

NOTE: There is a possibility that you may see 2 sensors with the same decimal ID number engraved on the housing, but for processing the sensors specific ID, the ECU uses the full MAC address.

Errors - Live internal hardware errors are shown when present.

Warnings – Indicates pressure or temperature warnings, pressure warning is set at 1500mBar which is the legal minimum for ECE and FMVSS and will indicate a sensor below this pressure

Pressure - Displays the gauge pressure for the sensor currently detected.

Temperature - Displays the temperature for the sensor currently detected.

Battery - Displays the remaining battery life for the sensor currently detected.

ECU signal strength – Indicates the average received signal strength of the sensor currently detected by the ECU.

Sensor connection info – use the + to expand the sensor connection information

Received timeout – Indicates if the sensor has been received within the timeout period set

Rx counter – Indicates the received data packet counter on a 0 to 255 scale

Confirmed status – Indicates if the sensor has been confirmed

Detected status – Indicates if a sensor has been detected

If the compensated pressure setting is enabled, the temperature compensated pressure to the reference pressure set will be displayed for the reference pressure.

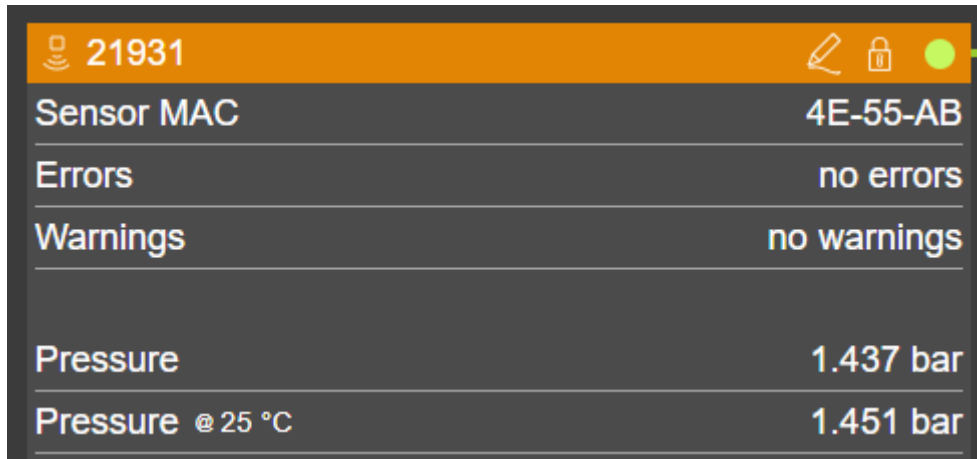

The screenshot shows a TPMS interface with a dark grey background and white text. At the top, there is an orange header bar containing a signal strength icon, the number '21931', and three icons: a pencil, a lock, and a green circle. Below the header, the interface is divided into several sections by horizontal lines. The first section shows 'Sensor MAC' as '4E-55-AB'. The second section shows 'Errors' as 'no errors'. The third section shows 'Warnings' as 'no warnings'. The fourth section shows 'Pressure' as '1.437 bar'. The fifth section shows 'Pressure @ 25 °C' as '1.451 bar'.

21931	
Sensor MAC	4E-55-AB
Errors	no errors
Warnings	no warnings
Pressure	1.437 bar
Pressure @ 25 °C	1.451 bar

Figure 60 - Temperature compensated pressure displayed

12 1SYSTEM® Security

NOTE: The following section requires a CORE PLUS or higher licence to make changes to security.

Previous TPM systems from bf1systems implemented a permit list to keep the sensor data secure to the team.

1SYSTEM® does not require the need for a permit list, each sensor and ECU has a security code to keep the data within your team.

The 1SYSTEM® security consists of 2 levels, these are:

1. 1SYSTEM® Security code
2. Vehicle ID (such as car number)

When purchasing new 1SYSTEM® components, the specific security codes must be confirmed to ensure the correct parts are received, for instance, if you are racing with a manufacturer supplied car such as Porsche, Ferrari or Aston Martin or within a specific series.

The security for your setup will be displayed on the license page in the 1SYSTEM® app.



Figure 61 - Security codes

The security code within the wheel sensors will need to match the ECUs otherwise the sensor data will not be processed or passed through to the logger, this will be indicated by the 1SYSTEM® PC software shown in Figure 62 and also in the CAN data message 'TPM1S_XX_WS_DATA' (default ID 0x600, 0x601, 0x602 or 0x603) signal 'TPM1S_XX_WS_MISMATCH' will be set to TRUE (WS security code mismatch)

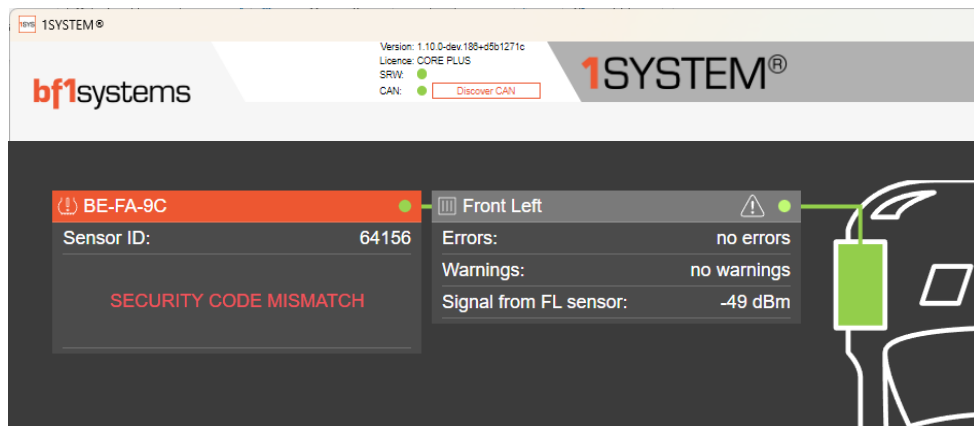

Figure 62 - Security mismatch

12.1 Updating Security Codes

If you have multiple security codes within your license you can update the ECU and sensors for each security code.

12.2 Sensor Claiming

Sensor can be claimed using either the 2.4GHz connection of the laptop or tablet, or by inputting the Sensor Validation Code (SVC). Unclaimed sensors show in the 1SYSTEM® app ALL page and are highlighted in a brown.

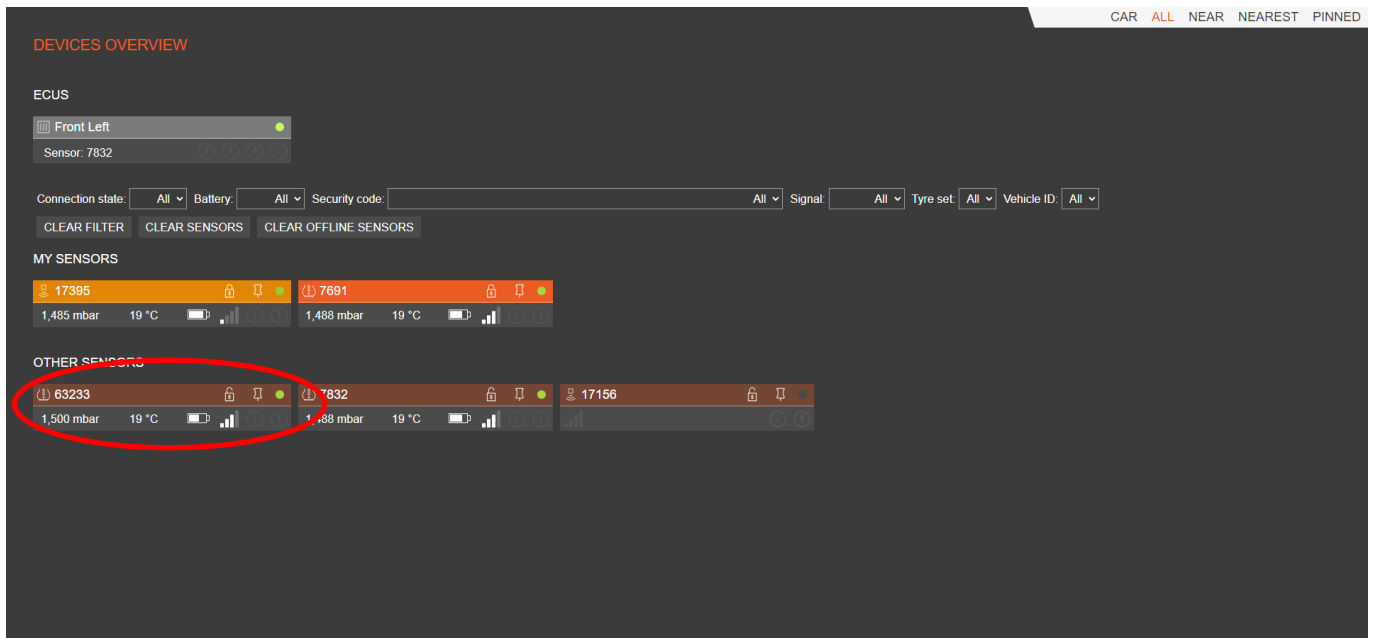
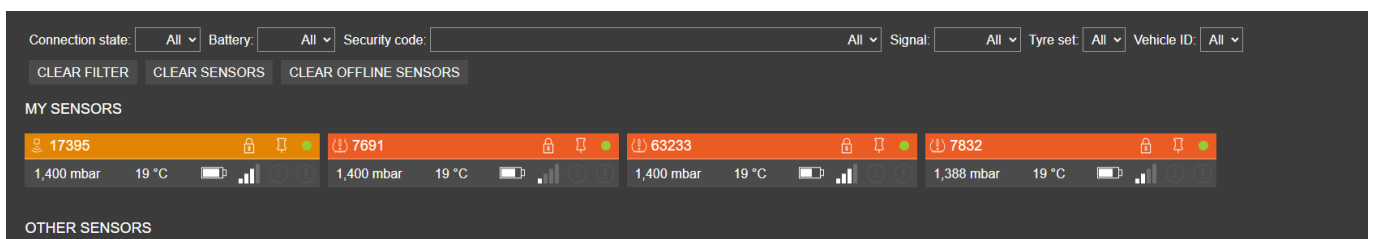

Figure 63 - Unclaimed sensors highlighted in brown

12.3 Claiming A Sensor Over the Wireless Connection

To claim using a 2.4GHz connection, place the PC or tablet close to the pressurised sensor, if the sensor serial number is not known the nearest page of the 1SYSTEM® app can be used, to be able to claim the sensor, the signal strength must be -50dBm or higher, then click on the padlock icon of the sensor detail box. If the sensor has a strong enough signal the claim will be accepted and the box colour will change to orange.



If the signal is not strong enough the user will be prompted to input the SVC to claim the sensor, see section 12.4.

12.4 Claim Using Sensor Validation Code - SVC

A sensor displayed in the Other Sensors screen can be claimed at any time if the SVC is known.

The SVC is marked on the sensor as a 3-digit number within a rectangular box.

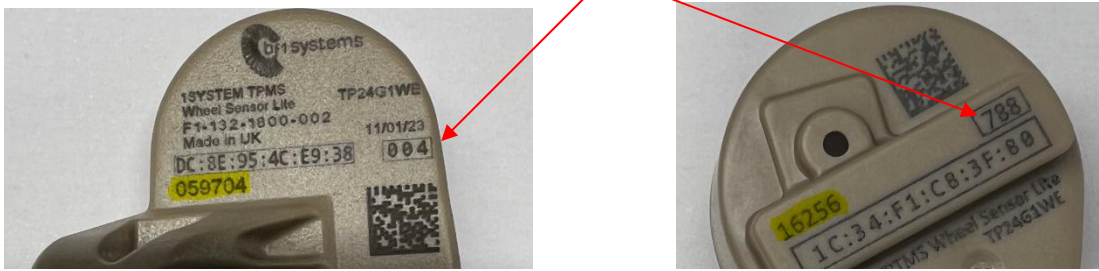

Figure 64 - Sensor SVC code

Find the sensor to be claimed from the other sensor list and click the padlock icon, the user will be prompted to enter the SVC code. Once the code is entered, the sensor will shift to the My Sensors list and the box will change to orange.

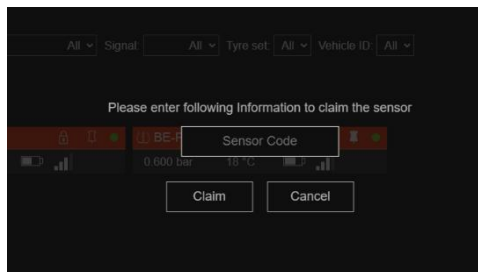

Figure 65 - Sensor claiming using SVC code

If the sensor is not pressurised and therefore not visible in the app, it can be claimed by inputting the full MAC address and the SVC code, select the claiming page from the Application Configuration page, then select ADD SENSOR, a popup box will be shown to input the MAC address, the SVC and any memo notes you wish to add.

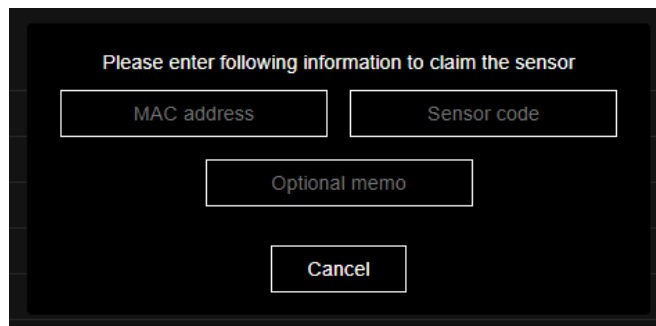

Figure 66 - manually input sensor claiming

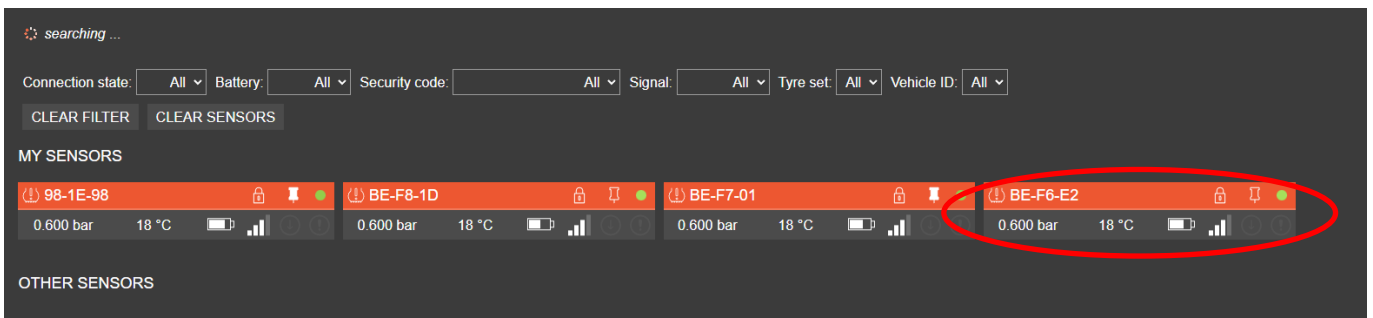

Figure 67 - Claimed sensors highlighted in orange

12.4.1 Importing and exporting Claim lists

Once claimed into a 1SYSTEM® app, the claim list can be exported and shared with other members of the team.

To export a claim list, select the Application Configuration then Claiming

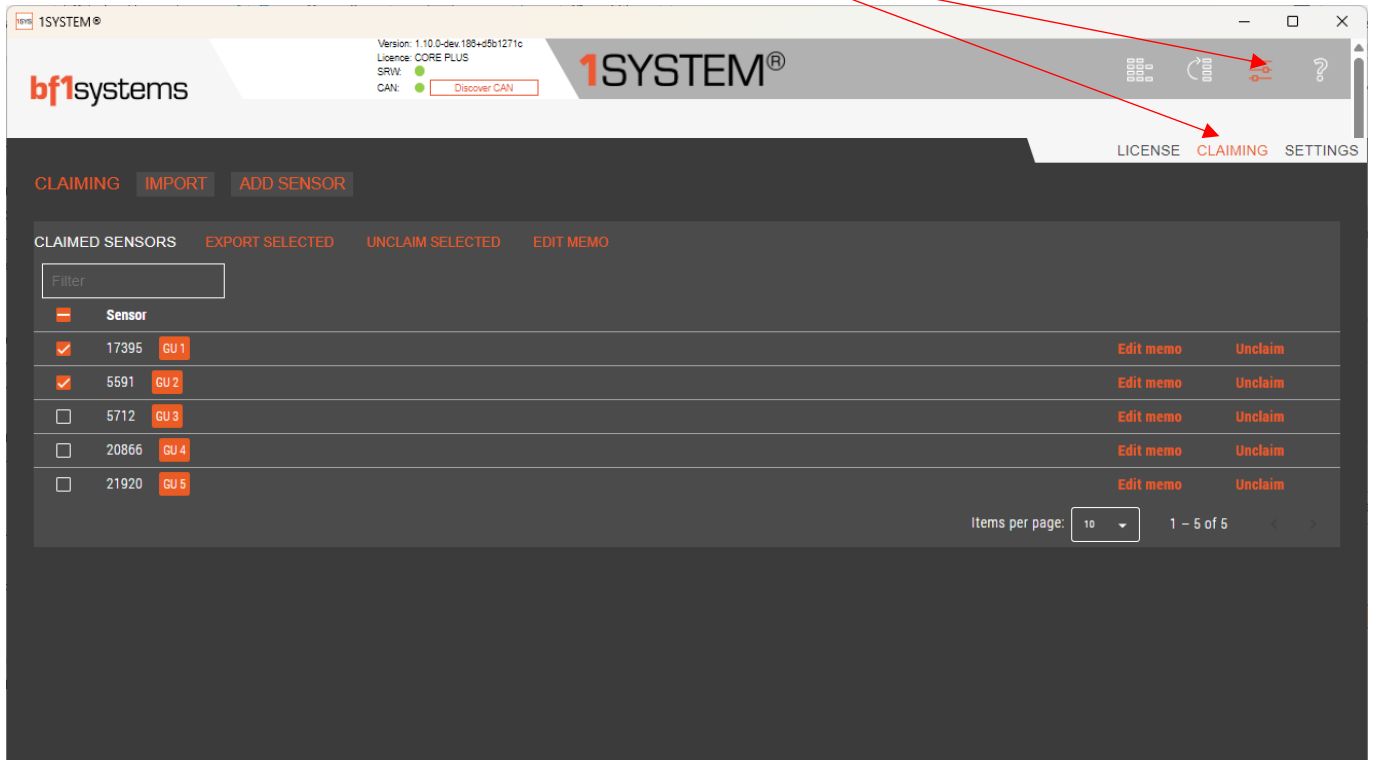

Figure 68 - Claiming page

Select the sensors that are going to be exported, either by selecting the tick box next to the serial numbers or select all using the tick box at the top of the list.

Click on EXPORT SELECTED and navigate to the folder required to save the list:

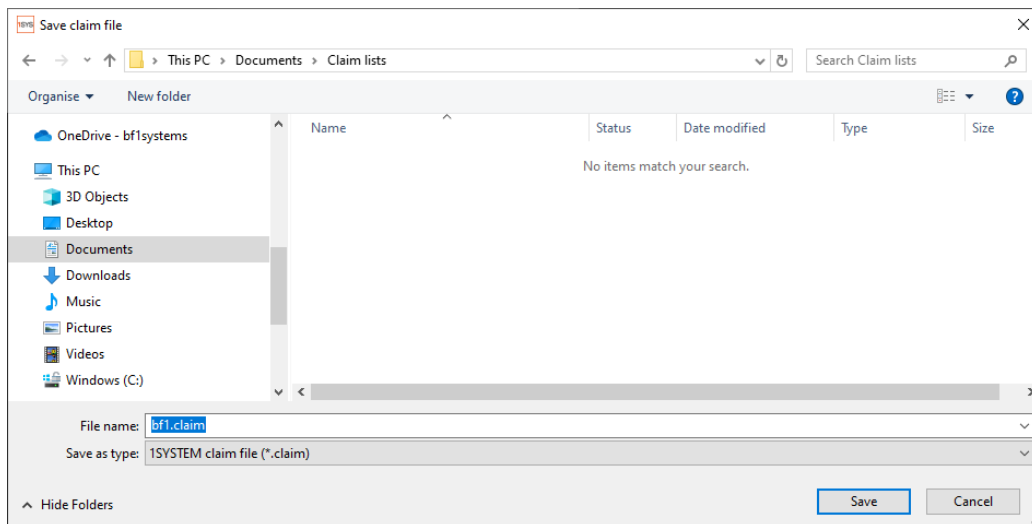

Figure 69 - Export and save the claim list

To import a claim list, select the IMPORT button, navigate to the file to be imported and open. You will be prompted to add a prefix to any associated memos or to skip importing the existing memos, update as you require and save, an acknowledgement will be shown when the list has been imported

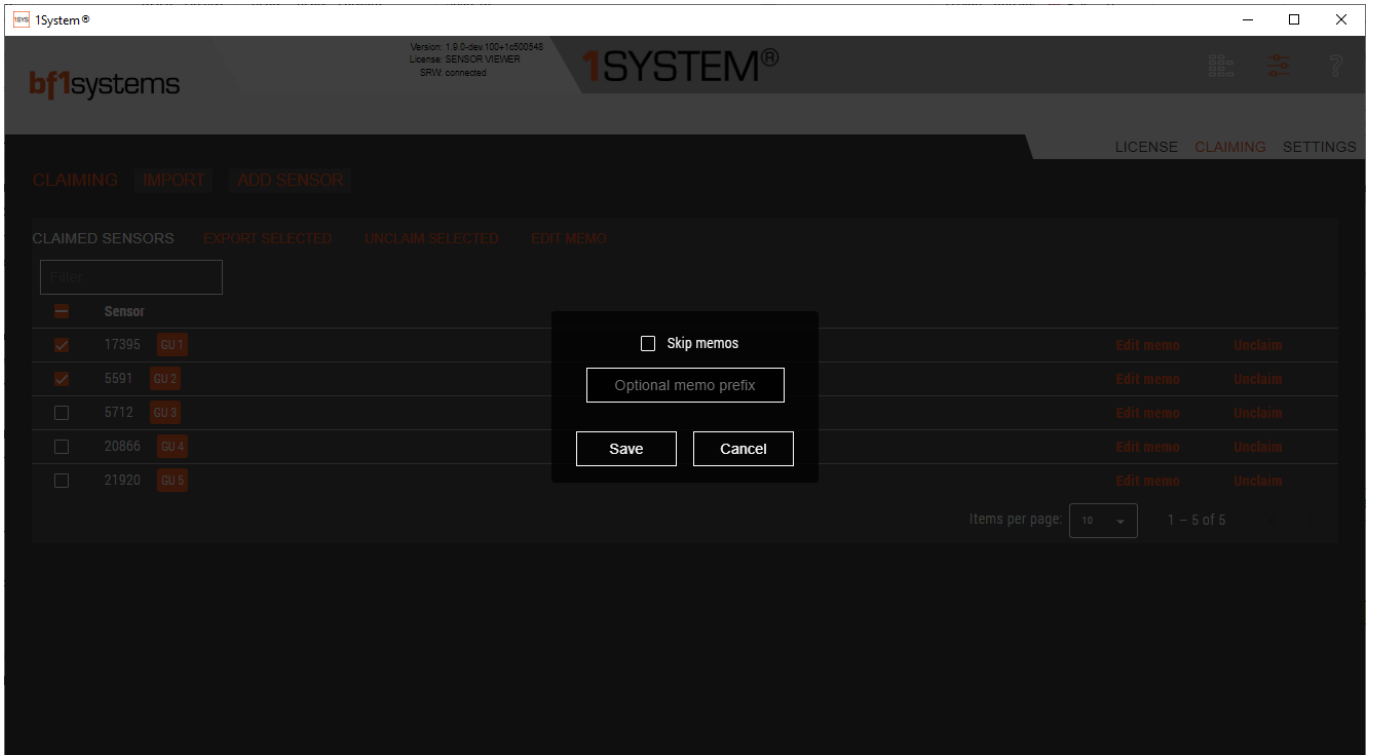

Figure 70 - Import update prompt

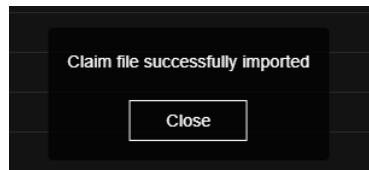

Figure 71 - Import acknowledgement

Any prefixes added to the sensor memo will be displayed in the list.

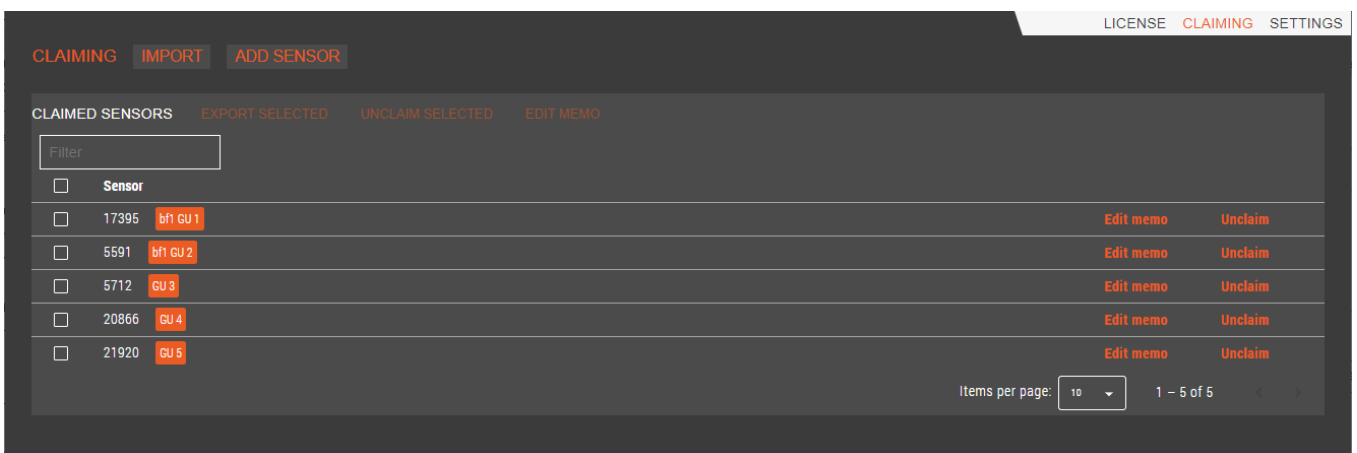

Figure 72 - Imported sensors updated

12.4.2 Memo Tags

When a sensor is first claimed, there will not be any memos tagged to the sensor.

To add or a new memo or to edit an existing memo, select the Application Configuration then Claiming

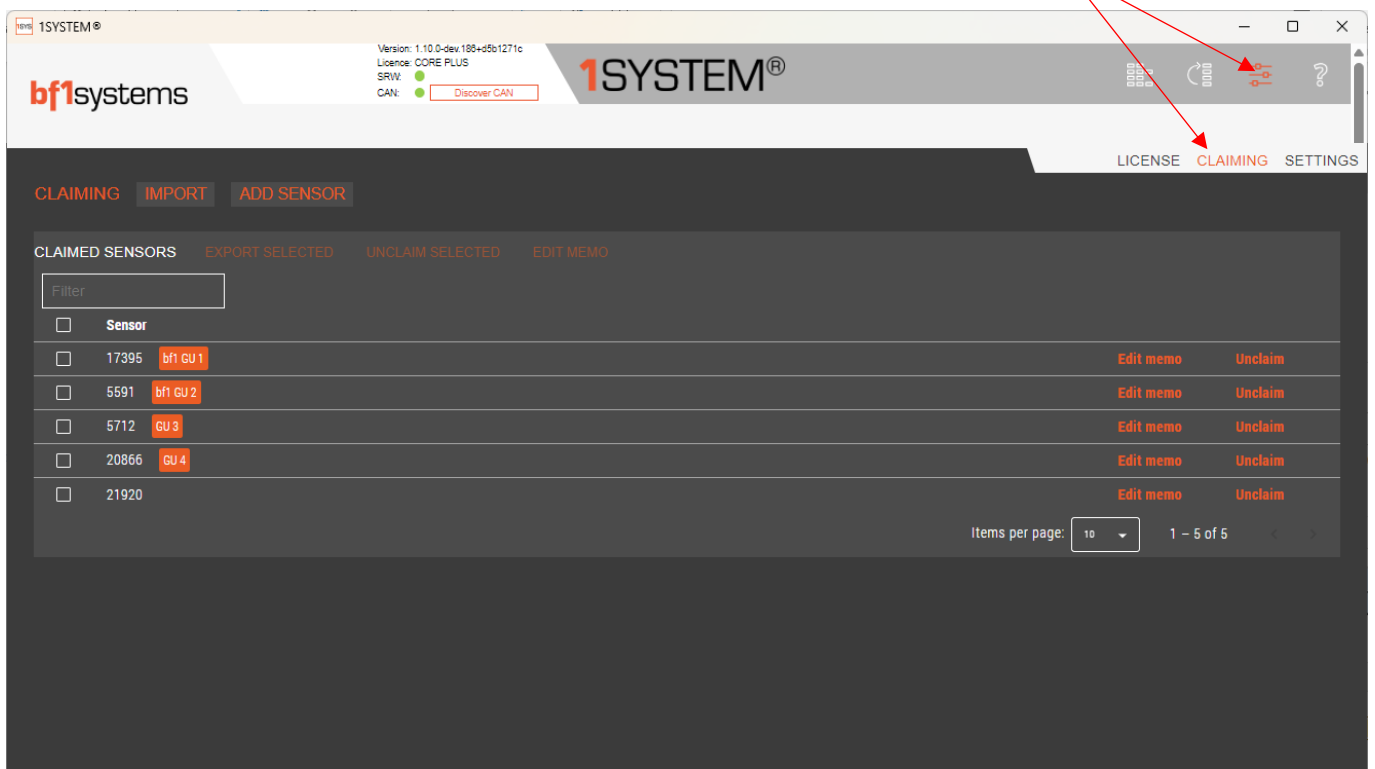

Figure 73 - Update memo's

Memos can be added or edited one at a time or as multiple parts.

To update a single sensor, click on Edit memo and a pop up box will show. Update and save the memo.

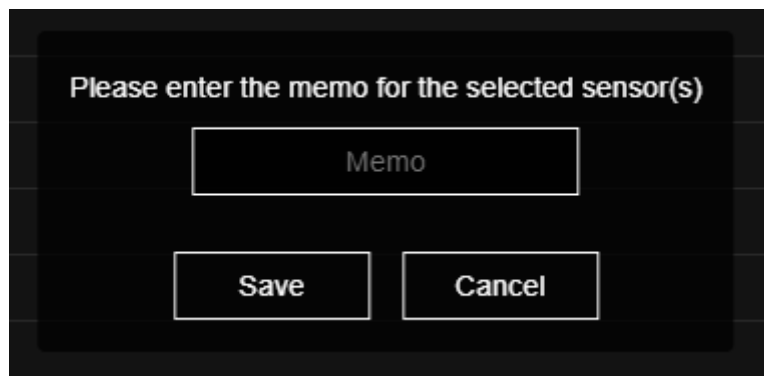

Figure 74 - Memeo update box

CLAIMED SENSORS		EXPORT SELECTED	UNCLAIM SELECTED	EDIT MEMO
Filter				
<input type="checkbox"/>	Sensor			
<input type="checkbox"/>	17395	bf1 GU 1	Edit memo	Unclaim
<input type="checkbox"/>	5591	bf1 GU 2	Edit memo	Unclaim
<input type="checkbox"/>	5712	GU 3	Edit memo	Unclaim
<input type="checkbox"/>	20866	GU 4	Edit memo	Unclaim
<input type="checkbox"/>	21920	FL wet car 1	Edit memo	Unclaim
				Items per page: 10 1 - 5 of 5

Figure 75 - Single sensor updated

To update multiple sensors with the same memo, select the tick box for the required sensors and then use the EDIT MEMO button

CLAIMED SENSORS		EXPORT SELECTED	UNCLAIM SELECTED	EDIT MEMO
Filter				
<input checked="" type="checkbox"/>	Sensor			
<input type="checkbox"/>	17395	bf1 GU 1	Edit memo	Unclaim
<input checked="" type="checkbox"/>	5591	bf1 GU 2	Edit memo	Unclaim
<input checked="" type="checkbox"/>	5712	GU 3	Edit memo	Unclaim
<input checked="" type="checkbox"/>	20866	GU 4	Edit memo	Unclaim
<input type="checkbox"/>	21920	FL wet car 1	Edit memo	Unclaim
				Items per page: 10 1 - 5 of 5

Figure 76 - Selected sensors for memo update

CLAIMED SENSORS		EXPORT SELECTED	UNCLAIM SELECTED	EDIT MEMO
Filter				
<input checked="" type="checkbox"/>	Sensor			
<input type="checkbox"/>	17395	bf1 GU 1	Edit memo	Unclaim
<input checked="" type="checkbox"/>	5591	FR Dry car 2	Edit memo	Unclaim
<input checked="" type="checkbox"/>	5712	FR Dry car 2	Edit memo	Unclaim
<input checked="" type="checkbox"/>	20866	FR Dry car 2	Edit memo	Unclaim
<input type="checkbox"/>	21920	FL wet car 1	Edit memo	Unclaim
				Items per page: 10 1 - 5 of 5

Figure 77 - Memo updated for selected sensors

Sensor memos can also be updated from the ALL, NEAR and NEAREST pages by clicking the pen icon on the sensor

The screenshot displays the 'DEVICES OVERVIEW' interface. At the top right, navigation tabs include 'CAR', 'ALL', 'NEAR', 'NEAREST', and 'PINNED'. The main heading is 'DEVICES OVERVIEW'. Below it, the 'ECUS' section is visible with a 'show' link. A 'Hide sensor filter' panel contains several filters: a search box, 'Connection state: All', 'Battery: All', 'Security code: All', 'Signal: All', 'Tyre set: All', 'Vehicle ID: All', 'Wheel position: All', 'Sensor type: All', 'Memo: All', and 'FW: All'. A 'Sort by: No Sorting' dropdown is also present. Action buttons include 'CLEAR FILTER', 'CLEAR SENSORS', and 'CLEAR OFFLINE SENSORS'. The 'MY SENSORS' section is expanded, showing a list of sensors with their serial numbers, models, and status. Each sensor entry includes a pen icon for editing the memo.

Serial Number	Model	Status	Action
17123	Up!	Claimed	Pen icon
20023	RS2000	Claimed	Pen icon
19490	RS2000	Claimed	Pen icon
19998	RS2000	Claimed	Pen icon
16490	RS2000	Claimed	Pen icon
23367		Claimed	Pen icon
18557	Golf R	Claimed	Pen icon
18558	Up!	Claimed	Pen icon

12.4.3 Unclaim sensors

Claimed sensors that are no longer used will show on the claim page and the Device overview page, these can be unclaimed and will therefore no longer be shown leaving only the current sensors being used.

To unclaim a single or multiple sensors, navigate to the claiming page then click the Unclaim for the required sensor.

To unclaim multiple sensors, select the sensors using the tick boxes next to the serial number, then use the UNCLAIM SELECTED button.

12.5 Updating Wheel Sensors

Sensors can be updated individually from the sensor configuration page.

Before a sensor can be updated it must be claimed. See Section 12.2 for instructions on how to claim a sensor.

To update a wheel sensor, place the pressurised sensor close to the laptop or tablet, then select the All screen to display the sensors close by then select the sensor from the list.

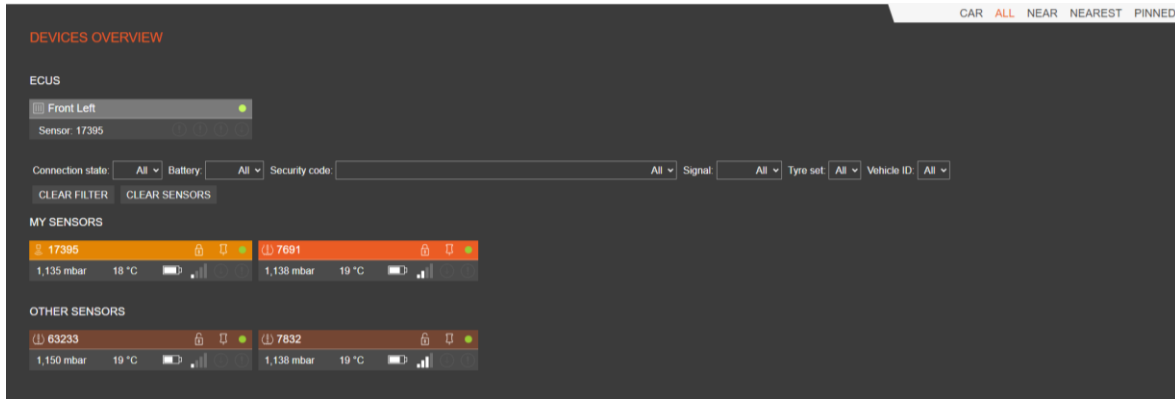

Figure 78 - All sensor overview page

Read the Characteristics from the sensor



Figure 79 - Selected sensor details

NOTE: Sensors cannot be updated if their temperature reading is above 85°C

Factory configuration – Displays the sensor type

Security code - Select the security code from the drop-down list and write the new code to the sensor.

Tyre set – enter the set number the sensor is allocated to, 0 - 127

Tyre type – enter the tyre type number, 0 – 15

Vehicle ID – enter the vehicle number, 0 – 31,

NOTE: the vehicle number must match the vehicle number set in the ECU or the data from the sensor will not be transmitted by the ECU.

Activation temperature – See section 18.4

Enable IR Points - See section 17

Idle activation delay time – Set the time in seconds before the sensor enters the Idle state

Idle activation delta pressure – Set the delta pressure change required to bring the sensor out of Idle state into slow transmit state

IR activation temperature – See section 18.4

IR RBL zero reference temperature – When active, IR has a greater drain on the battery than standard TPMS mode. Due to this, IR cannot always be sustained reliably at low RBL or low temperatures.

The parameter 'IR RBL zero reference temperature' is used to determine the temperature when IR can be reliably maintained, and re-scales the RBL percentage accordingly. By default, it is set to 50°C. Using the default value of 50°C, the RBL behaviour will be consistent with that observed in earlier firmware versions where this parameter was not present.

If you want the RBL to indicate 0% when IR is no longer guaranteed to operate at 20°C, then set this parameter to 20°C. This re-scales the RBL and providing the re-scaled RBL is still greater than 0%, IR will function reliably at 20°C and above. By setting a lower temperature, the rate of RBL reduction will appear to be more rapid. This is since lower running temperatures will result in lower voltage being supplied from the battery whilst powering the IR elements in the sensor. The sensor may continue to work in TPMS mode only if the indicated RBL reached 0%. NOTE: when the sensor is 'warm' it is possible/likely to get IR readings with 0% RBL.

Scenario 1

If tyres are always pre-heated before running, then a setting of 50°C will mean a representative RBL percentage will be shown throughout the life of the sensor, as it counts down from 100% – 0%.

Scenario 2

If tyres are not pre-heated before going on track, but IR data is only required when sensors exceed 50°C, then a setting of 50°C will still result in a representative RBL percentage throughout the life of the sensor as it counts down from 100% – 0%.

Scenario 3

If the tyres are not pre-heated before going on track, but IR data is required from a lower temperature such as 20°C, then a setting of 20°C will still result in a representative RBL percentage throughout the life of the sensor, as it counts down from 100% – 0%, as the RBL is re-scaled accordingly

13 All Page

The 'All' page displays all sensors, claimed & unclaimed received over the built in 2.4GHz receiver and ECUs connected via CAN. By default, all sensors claimed on the User's PC or tablet will be displayed, live sensors will show the green dot. To remove any sensors that are no longer online click on the 'CLEAR OFFLINE SENSORS' button.

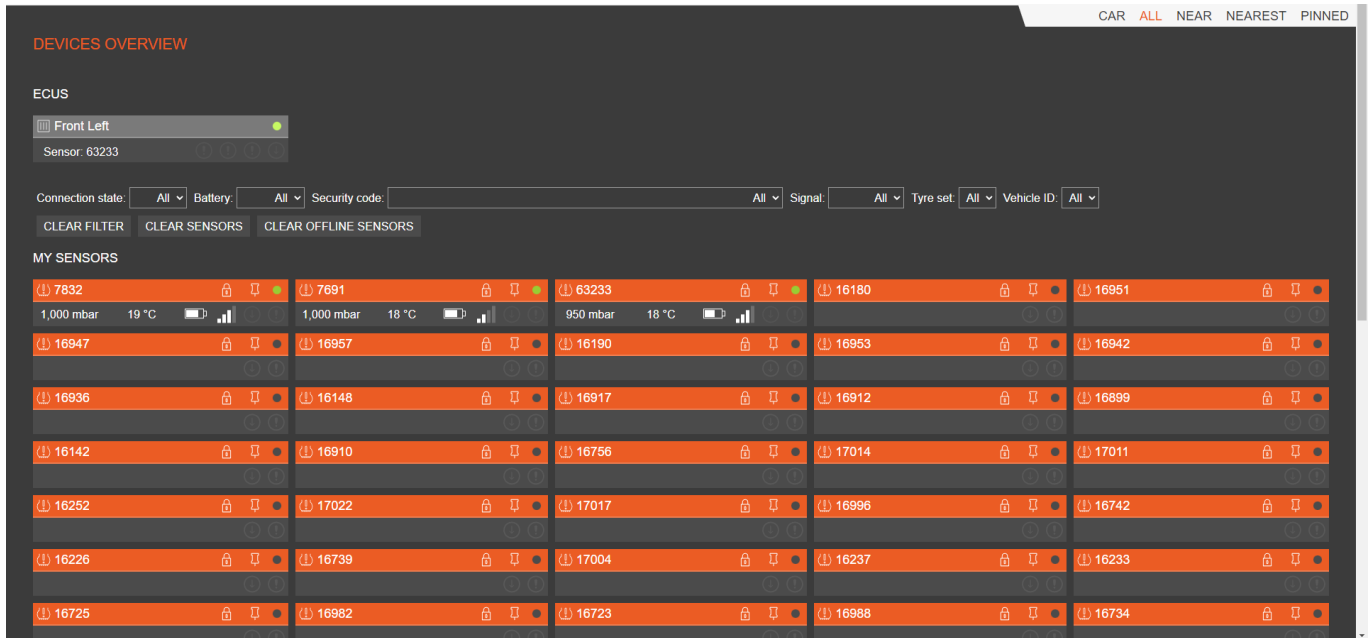

Figure 80 - All Sensors displayed page

TPMS and IRTPMS sensors are shown in different shades of orange and display different icons.

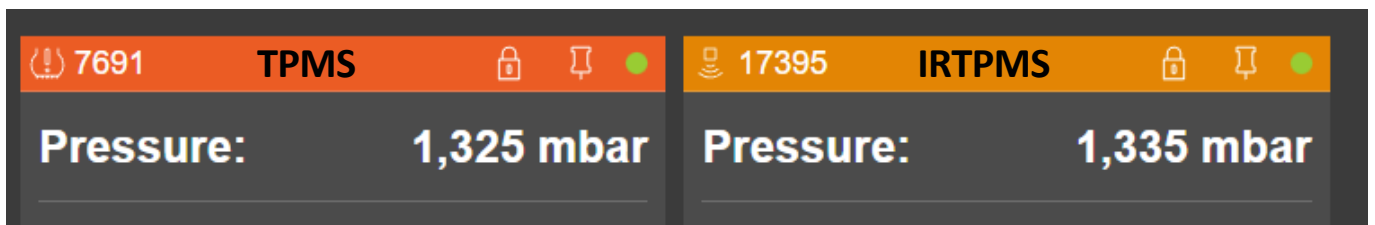

Figure 81 - TPMS and IRTPMS sensor identification in App

Sensors can be filtered using the drop-down categories or by serial number (serial or MAC) shown in Figure 82.

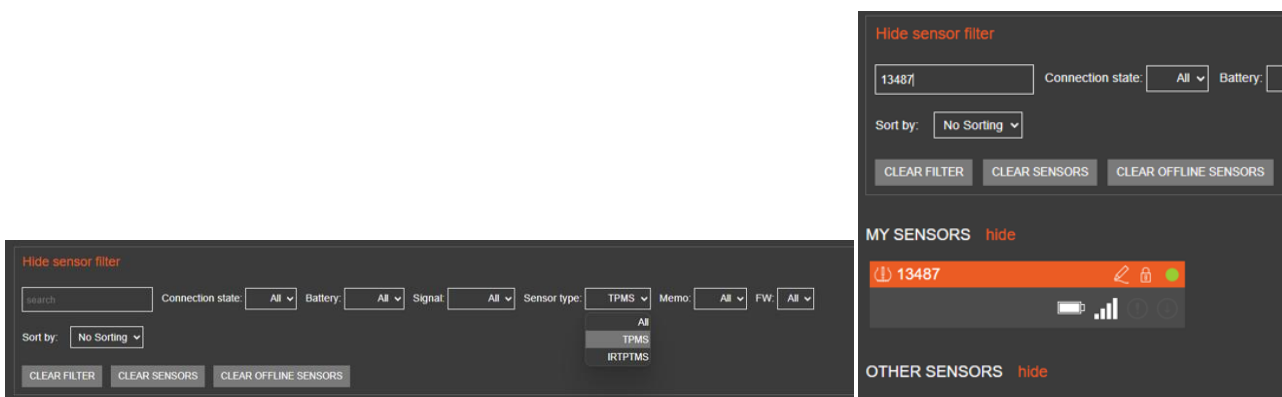

Figure 82 - Sensor filtering

14 Near Page

The 'Near' page will display the 4 sensors with the strongest signals. This page can be used to work with the wheels on the car or in a stack separated from the other tyres.

15 Nearest Page

The 'Nearest' page will display the sensor with the strongest signal.

16 Pinned Page

There will be times when you need to monitor specific sensors from all shown on the screen, this can be achieved by pinning the sensor. Up to four sensors can be pinned at one time.

To pin a sensor, click on the pin icon so the colour changes to white

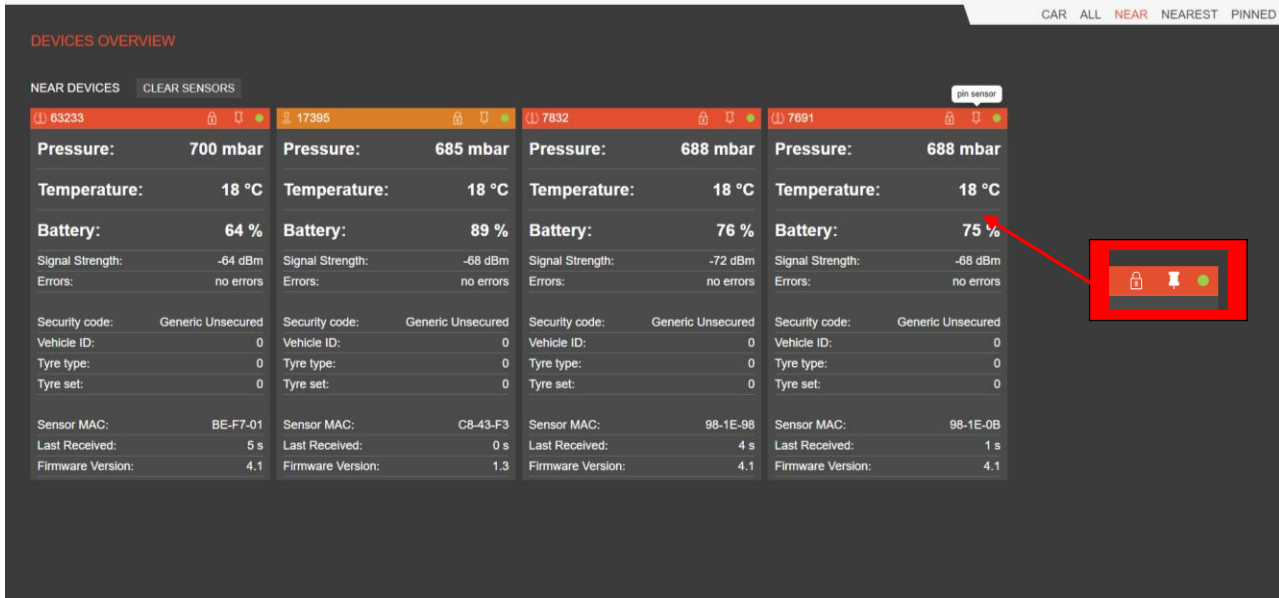

Figure 83 - Pinning a sensor

The pinned sensors can be viewed on the Pinned page

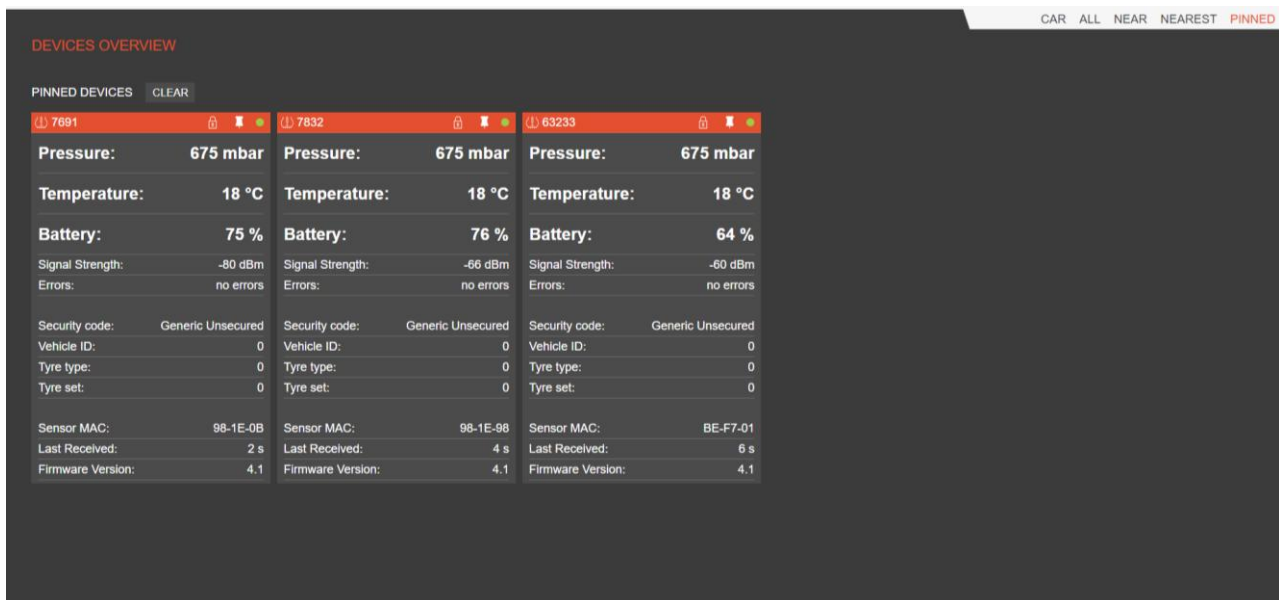

Figure 84 - Pinned sensors

To unpin the sensor, click the pin icon again.

17 IR Sensor Pixel selection

Select the sensor to be configured from the 'ALL' or 'CAR' pages, this will take you to the sensor characteristics page, Figure 85. Sensor must be pressurised to display the details.



Figure 85 - IR Sensor Characteristics page

Depending on the sensor mode, the current IR temperatures may be shown. To show the temperatures if not present, bounce the wheel or shake the sensor if in a pressure bottle.

Select the pixel selection pop up by clicking the icon in the Temperatures row



The pixel pop up will show

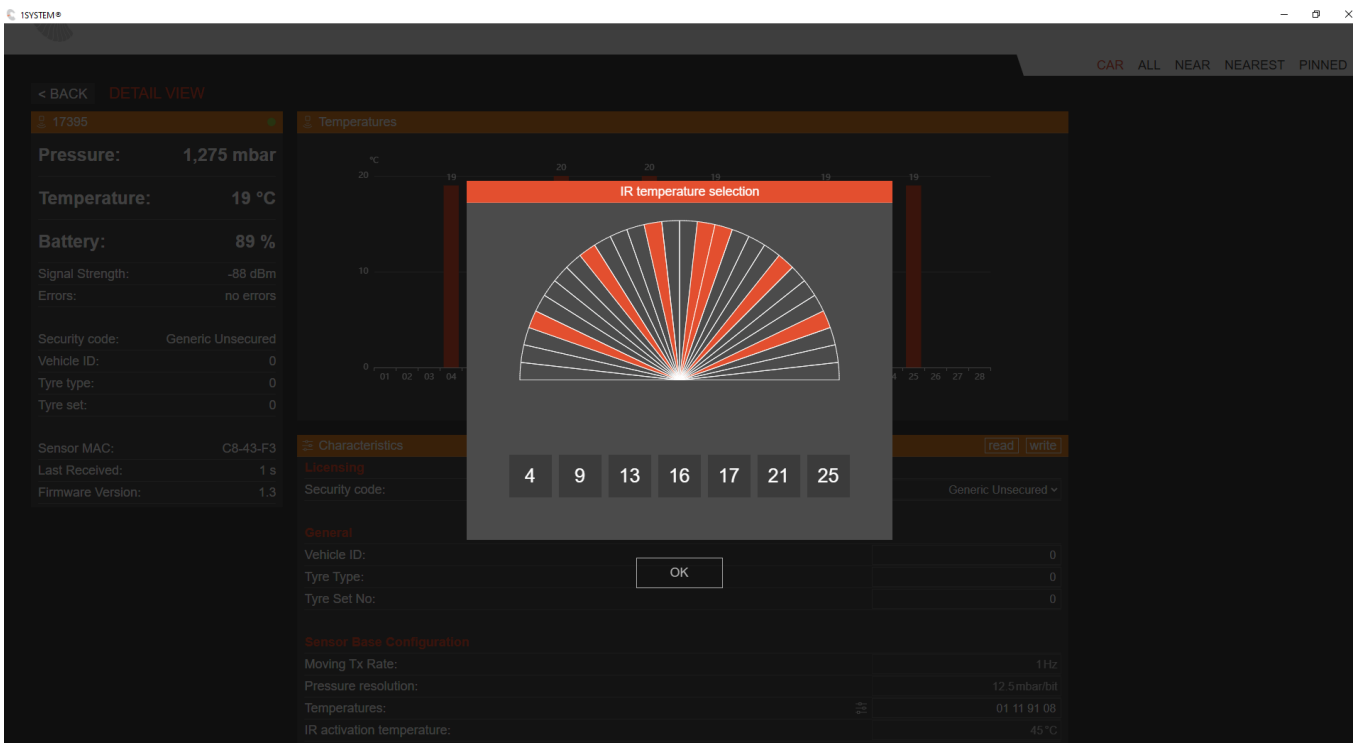

Figure 86 - Pixel selection pop up

Click and hold on the orange triangle of the pixel you wish to change and drag to the desired position.

When all pixels are in the desired positions, click ok then write to the sensor.

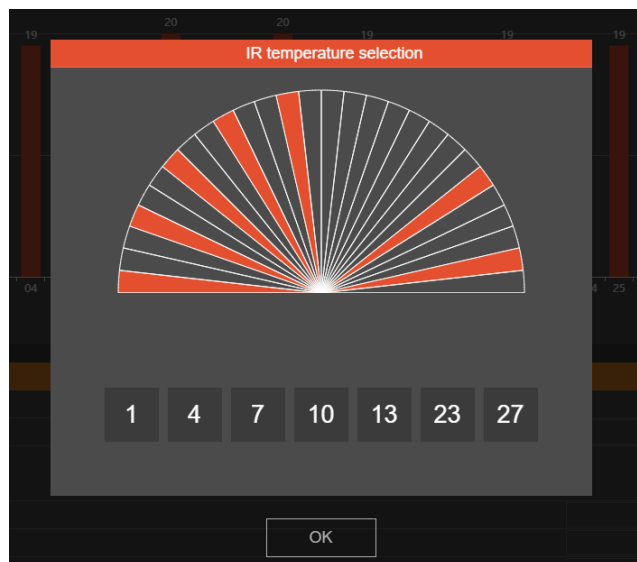

Figure 87 - Drag to change positions

NOTE: Sensors cannot be updated if their temperature reading is above 85°C

17.1 Pixel Layout

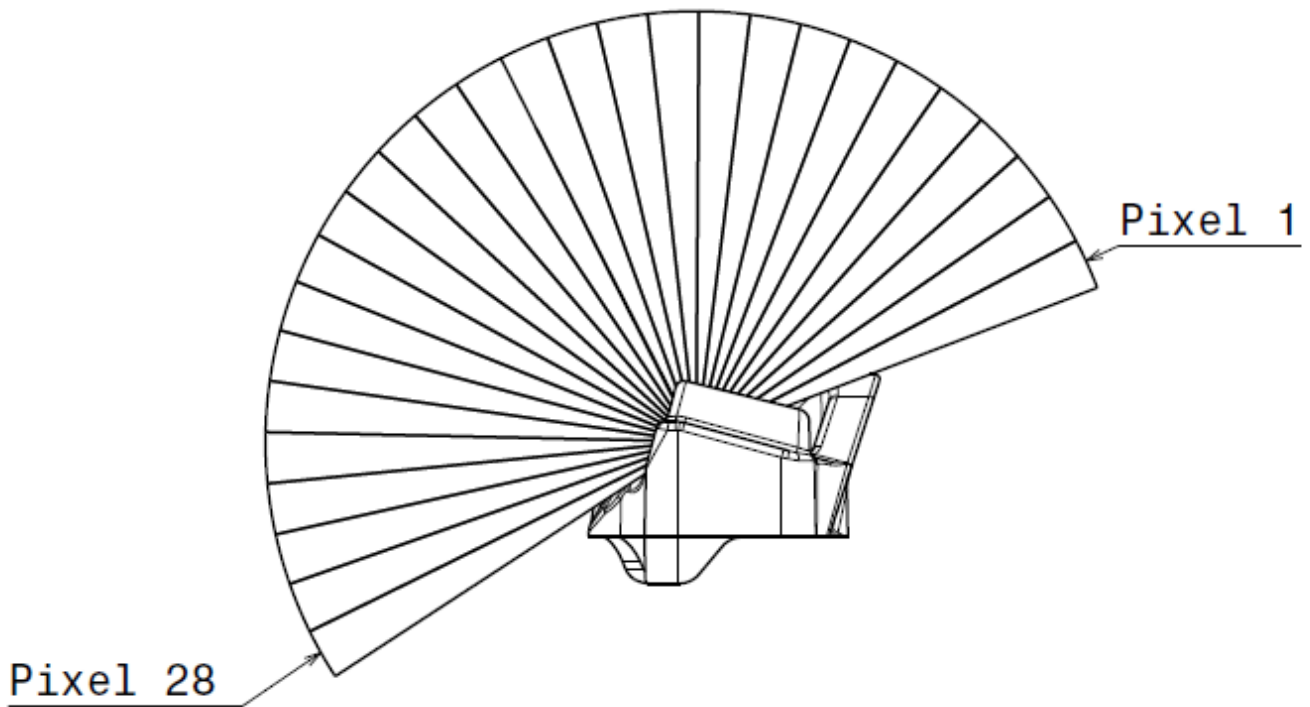

Figure 88 - IR pixel numbering

CAD for the IR sensor pixel layout can be requested from bf1systems, 1SYSTEM@bf1systems.com

18 Positioned system setup

The ECUs can be setup as a positioned system, when used in this mode the user can place 1 to 4 ECUs on the car depending on signal strength received from the sensors.

18.1 Setting ECU position

Using the monitored wheel position setup, the ECU can be set to receive the following positions on the car:

Monitored wheel setting	Receive sensors	Wiring Pin Assignment	
		LINK PIN 2 Lite ECU / (PRO ECU)	LINK PIN 6 Lite ECU / (PRO ECU)
AUTO	Not Applicable – set for learning system		
FL	Receive FL sensors only	No Connect	No Connect
FR	Receive FR sensors only	LINK PIN 8 / (GND)	No Connect
FRONTS	Receive FL & FR sensors only	No Connect	No Connect
RL	Receive RL sensors only	No Connect	LINK PIN 7 / (GND)
LEFTS	Receive FL & RL sensors only	No Connect	No Connect
RR	Receive RR sensors only	LINK PIN 8 / (GND)	LINK PIN 7 / (GND)
RIGHTS	Receive FR & RR sensors only	LINK PIN 8 / (GND)	LINK PIN 7 / (GND)
REARS	Receive RL & RR sensors only	No Connect	LINK PIN 7 / (GND)
ALL	Receive FL, FR, RL & RR sensors	No Connect	No Connect



Figure 89 - Setting monitored wheel position

To allow an ECU to be placed in any position without a need to update, each position setup should be set for all possibilities.

Examples:

With 2 ECUs placed on the car, 1 front and 1 rear, set the Monitored wheel position set to:

FRONT	FRONT	REAR	REAR
-------	-------	------	------

For a 2 ECU system with 1 ECU Left and the other right set to:

LEFT	RIGHT	LEFT	RIGHT
------	-------	------	-------

For 3 ECUs, 1 front and 2 rear, set to:

FRONT	FRONT	RL	RR
-------	-------	----	----

Once set, an ECU set for multiple positions will transmit the ECU CAN data for the single ECU which it has been hardwired, therefore an ECU wire as a FL and configured as FRONTS will transmit the ECU TPM1S_FL_DIAG and the TPM1S_FL ECU_INFO only.

The wheel sensor data will be transmitted for all selected positions.

18.2 Setting sensor detection thresholds

When used as a position system the ECU can receive all wheels but will only process the data from the wheel set to a matching position. For this reason, a detection threshold is not taken into consideration, to improve the reception the threshold should be set to its maximum value of -90dbm for both TPMS and IR sensors.

IR wheel sensor detection threshold	-90 dBm
Monitored wheel position setups	ALI▼ ALI▼ ALI▼ ALI▼
TPMS wheel sensor detection threshold	-90 dBm

Figure 90 - Sensor detection threshold for positioned system

18.3 Positioning wheel sensors

When the sensor arrive, they are all set as FL by default, to use these in a positioned system, the sensor Characteristics will need to be updated for the corner they will be used on.

5591	
Pressure:	1.425 bar
Temperature:	25 °C
Battery:	97 %
Wheel position:	FL
Signal Strength:	-70 dBm
Errors:	no errors
Security code:	Generic Unsecured
Vehicle ID:	0
Tyre type:	0
Tyre set:	0
Sensor MAC:	4E-15-D7
Last Received:	5 s
Firmware Version:	1.3

Figure 91 - Default FL sensor

To update the sensor, read the characteristics using the 1SYSTEM® app.



Use the drop down for wheel position to select the required location, then write back to the sensor.

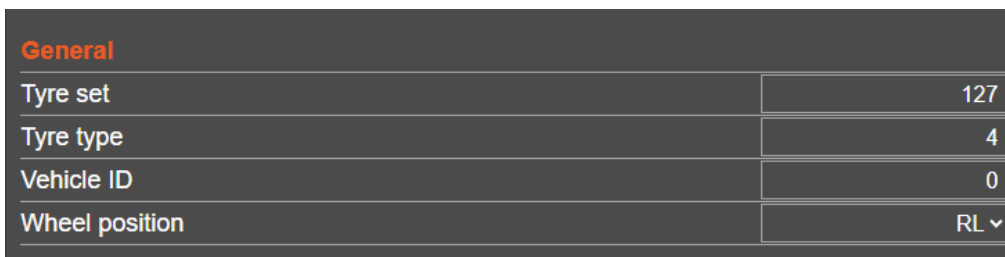

Figure 92 - Wheel position selection

18.4 Activation & IR Activation Temperatures

The activation temperature is used to set the sensor into fast transmit mode when the sensor is stationary. This can be used to monitor the sensors at a faster rate when being heated.

The IR temperatures are not transmitted when the sensor is stationary to save battery, in some cases it may be required to see the IR temperatures.

The IR activation temperature sets the IR temperatures to be transmitted when the sensor is in stationary or fast transmit mode.

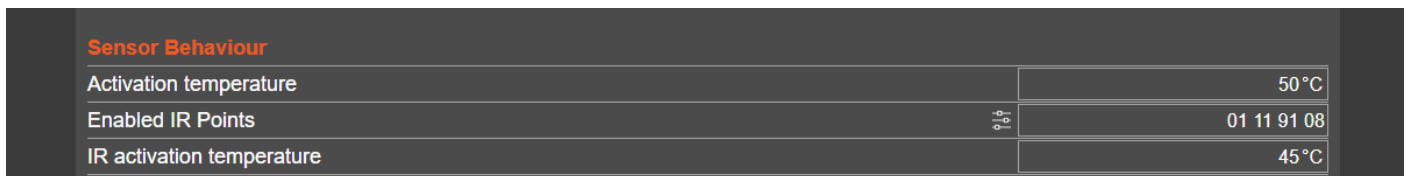

Figure 93 - Activation temperatures

Note:- Sensors sold prior to June 2025 have the default activation set to the 50° and 45° shown in Figure 93, it is recommended to raise these values if the data is not required, doing this will increase battery life of the sensor. Sensors sold after June 2025 will have default values of 100°C for both parameters

18.5 Display sensor position in 1SYSTEM® App

To indicate the sensor position when using the system as positioned, enable the 'Manual positioning' from the setting page.



Figure 94 - Enable Manual positioning for 1SYSTEM® App

When enabled, the sensor programmed position of the sensor will be displayed in the sensor details on all sensor pages.

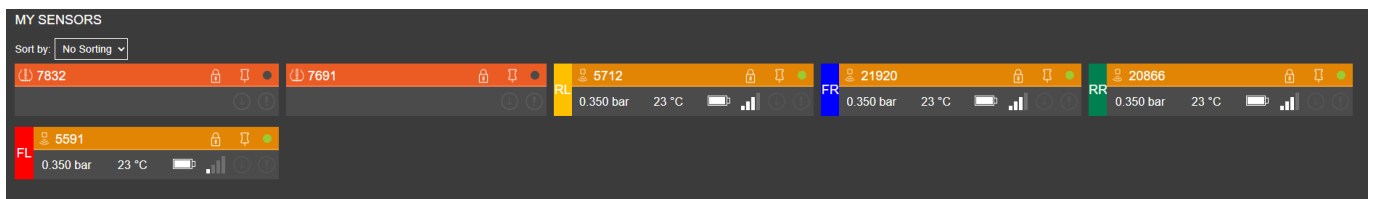

Figure 95 - Sensor programmed positions shown on 'All' page

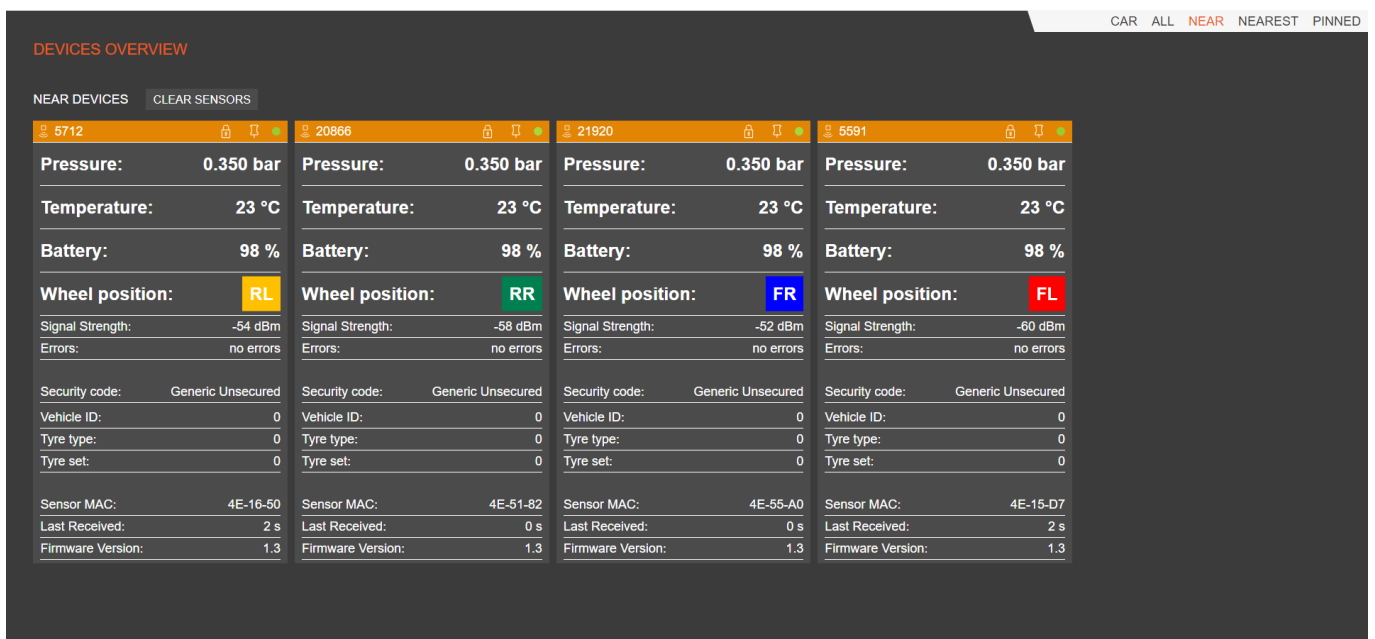
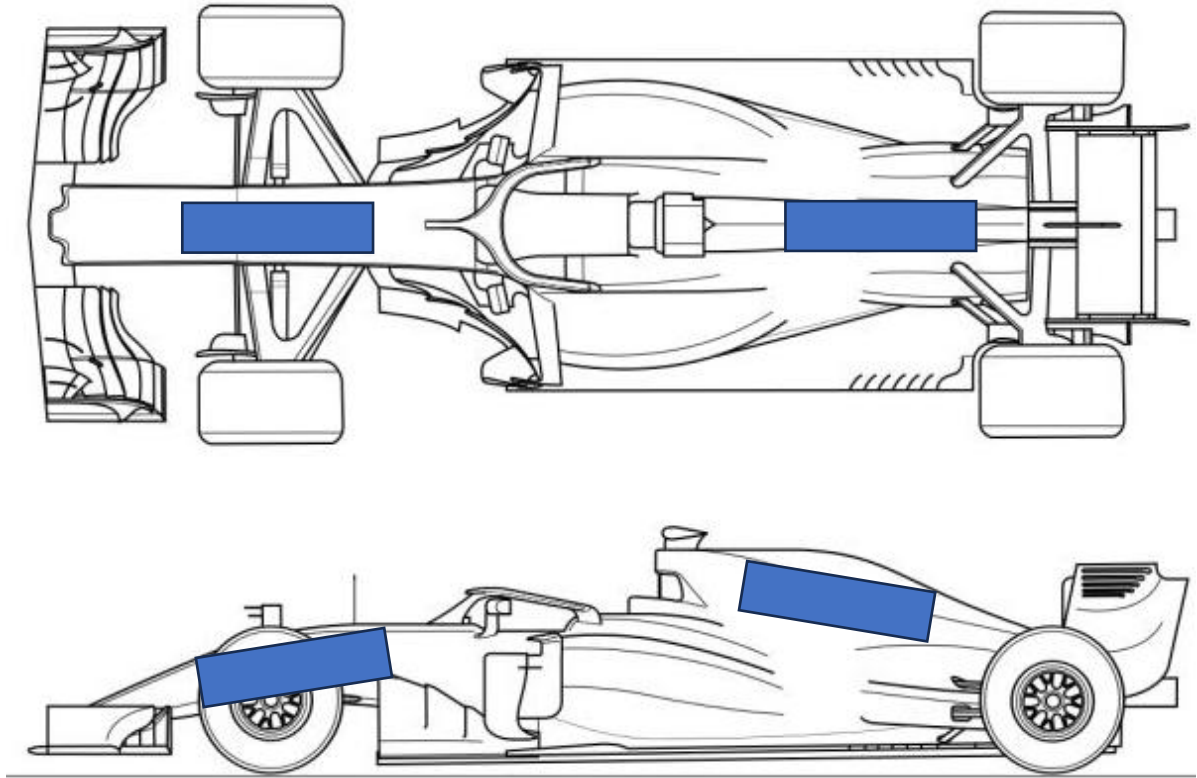

Figure 96 - Sensor programmed positions shown on 'NEAR' page

18.6 Positioned system mounting on an open wheeled car



Reception levels can vary greatly depending on the components surrounding the ECU and the size of window cut into the carbon body panels.

19 Projects

To access the full capability of the Projects page, a Core Plus licence is required.

To select the Projects page, click on the Projects icon in the top left corner:

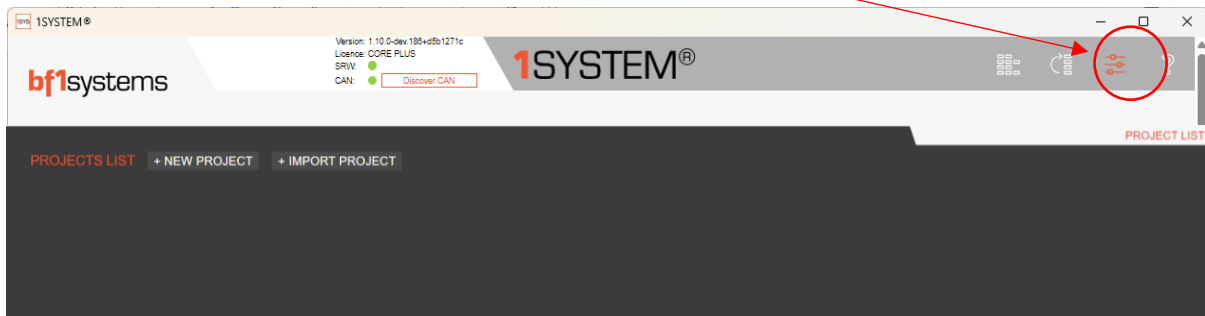

Figure 97 - Projects page

Opening the first time will show no Projects listed but a list will be populated as you save new Projects.

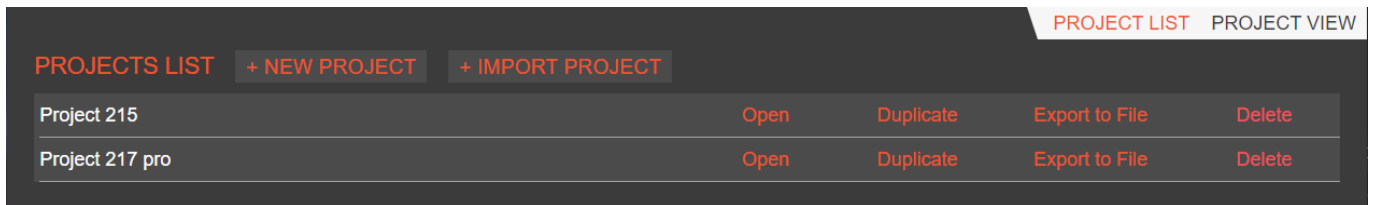

Figure 98 - Available Projects list

19.1 New Project

To create a new Project, click on +NEW PROJECT, a pop up notification will show, choose if you are using the system as an Automatic Positioning or as a Manual Positioning system.

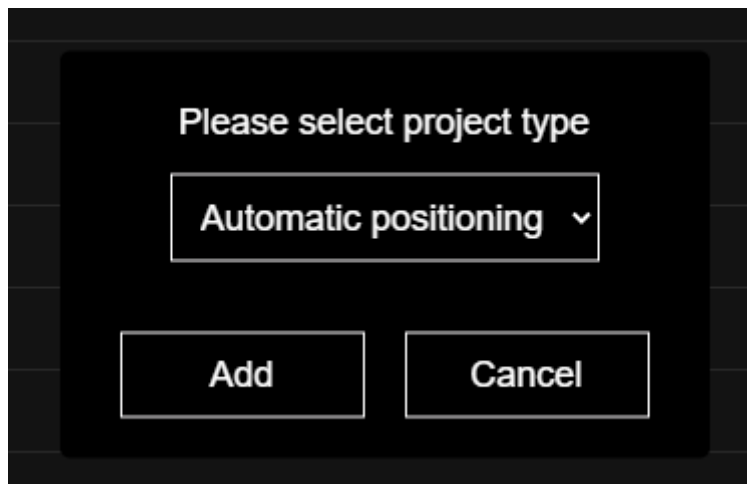

Figure 99 - Select Automatic or Manual Position system

A page displaying claimed sensors loaded into your own PC will show.

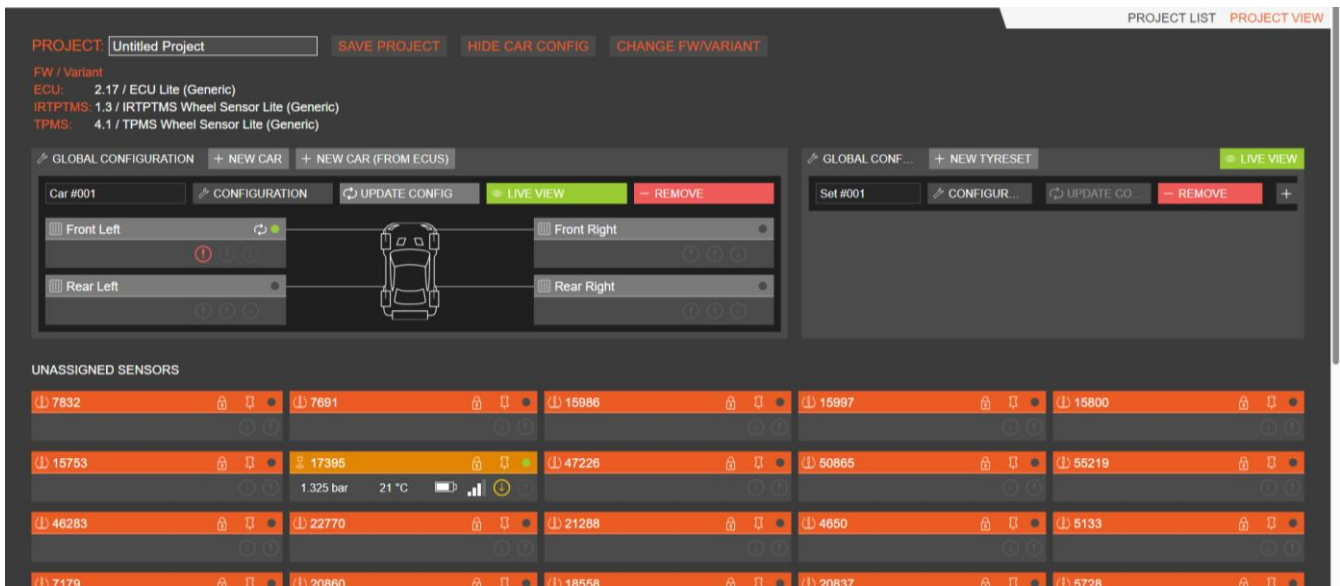

Figure 100 - New Project page

Name your project and save, this name will be displayed in the project list.

The ECU and sensor variants should be set to match the parts you have, click on the CHANGE FW/VARIANT button to see the variant selection page. Once selected, save the setup.



Figure 101 - ECU / Sensor variant selection page

19.2 Updating Tyre Sets

To create a tyre set, drag and drop the required sensor into the Tyre Set window, the set will show in green when the new tyre is held over the top to indicate which set the sensor is being added to.

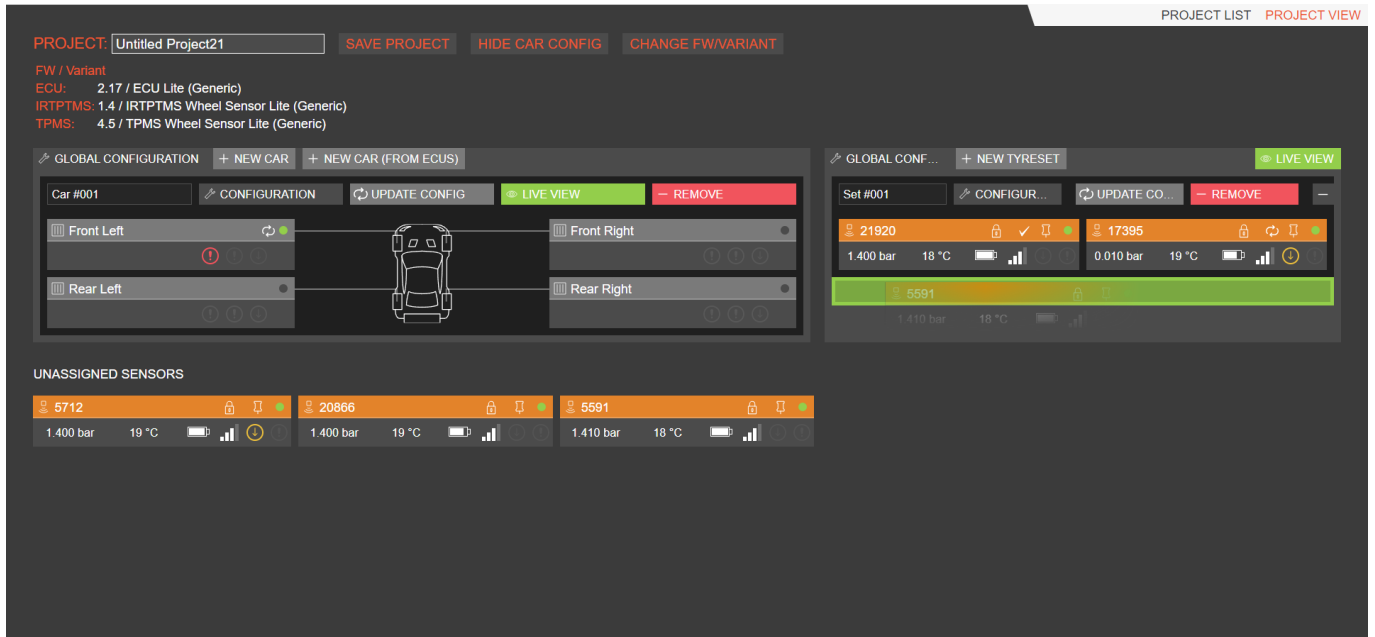

Figure 102 - Creating a Tyre Set – Automatic Positioning

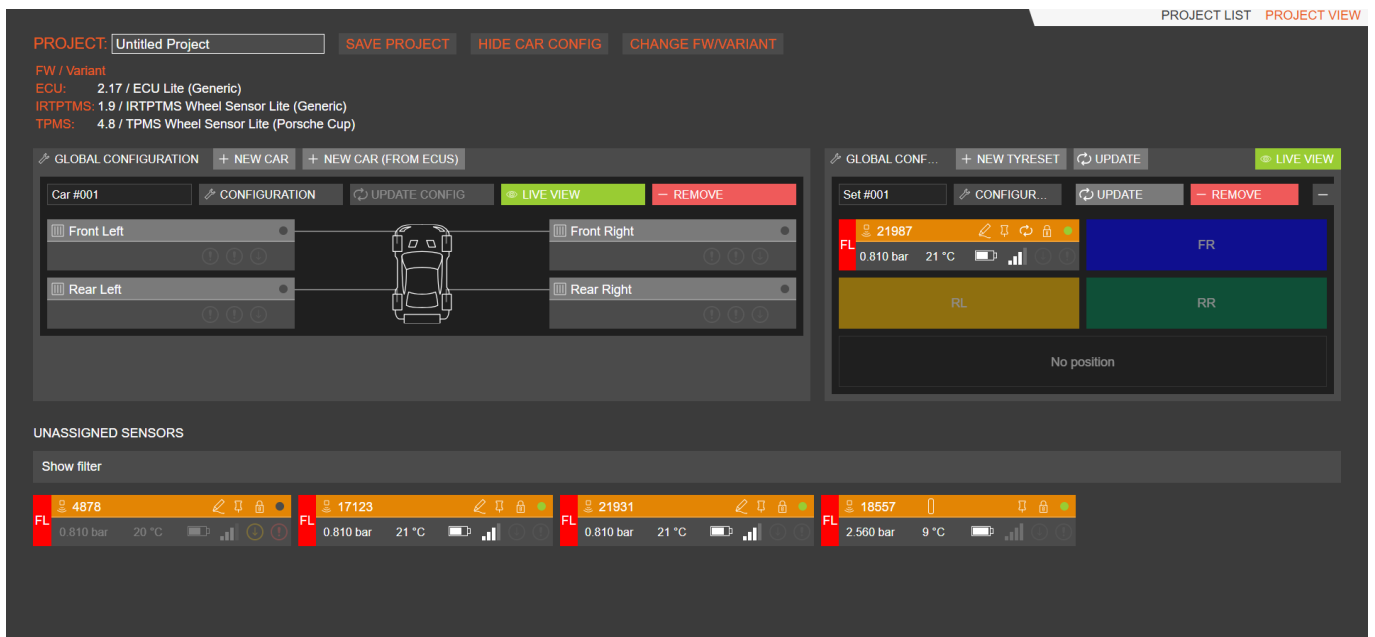

Figure 103 - Creating a Tyre Set - Manual Positioning

When Manual positioning is selected, the corners will be highlighted and sensors placed in those positions will be updated with their position when the config is written

If the sensor has an older version of firmware to the version selected for the project, then the firmware will be updated as well as the configuration.

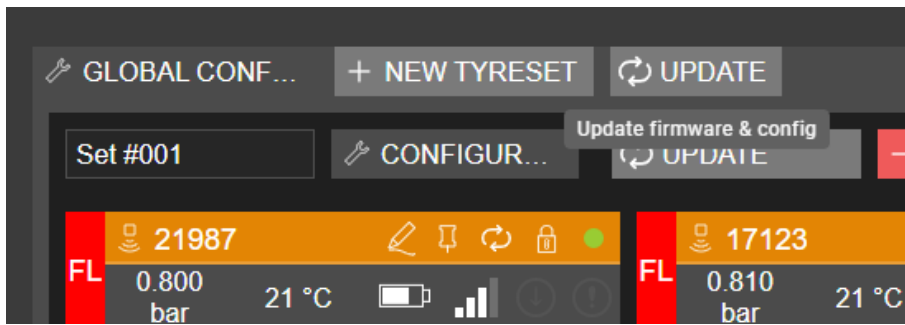

Figure 104 - Firmware and config update

The sets can be updated to a common configuration by selecting the 'Global Configuration' which will open a new page displaying the settings.

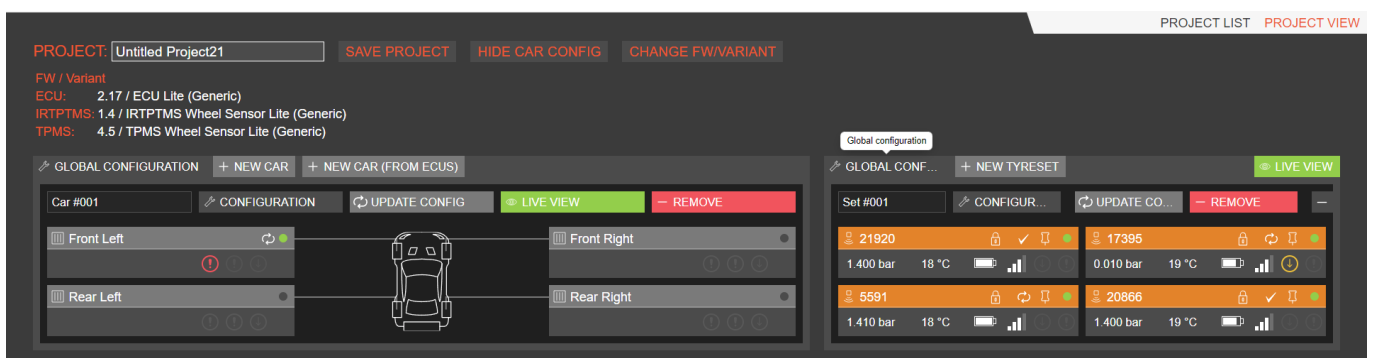

Figure 105 - Global config button

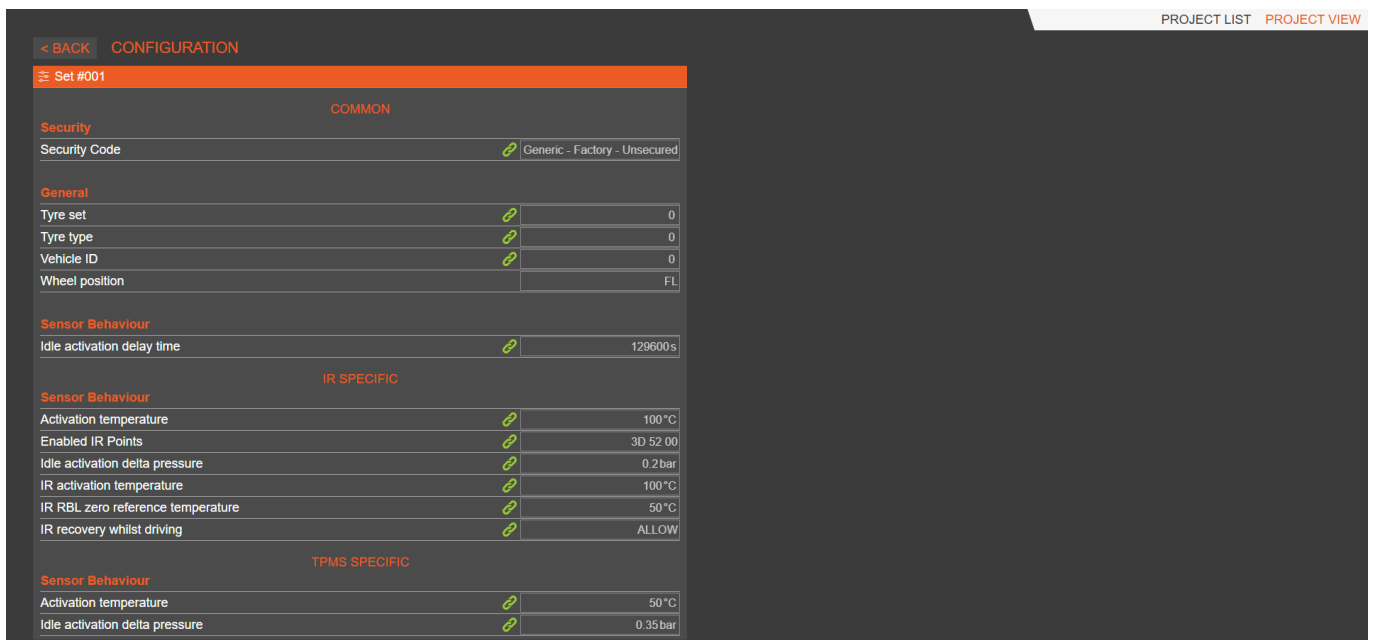

Figure 106 - Global tyre settings

Make your changes and click the BACK button and save the project.

To make individual changes to each set, such as the set number or tyre type, click the 'Configuration' button for the set,

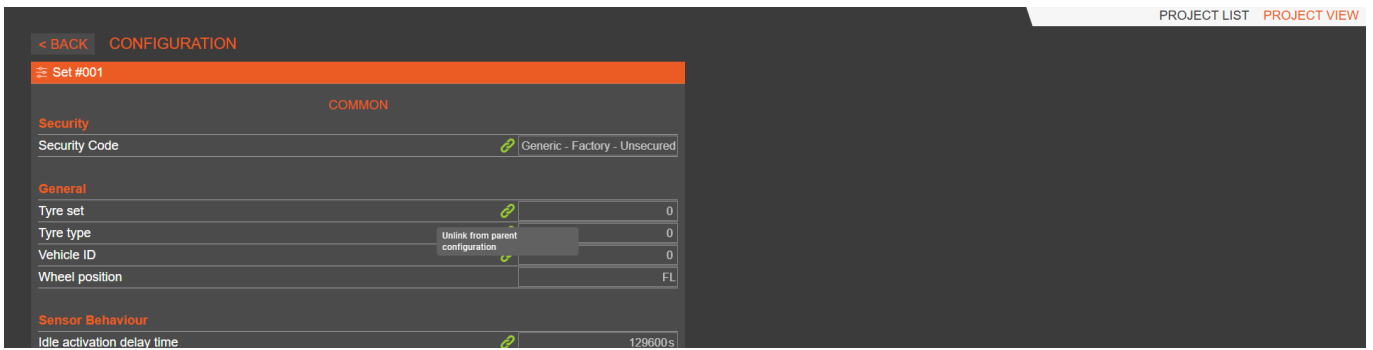
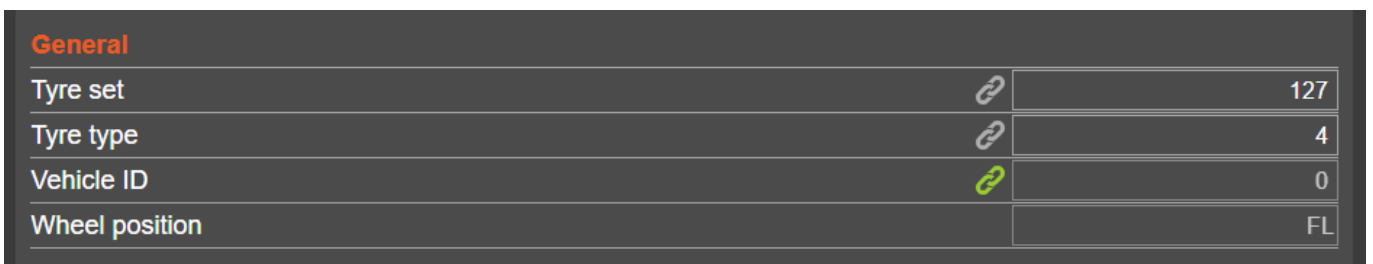

Figure 107 - Sensor configuration updated

To unlink the parameter from the Global Configuration, click on the green 'Link' icon, the icon will change to grey, then update the parameter.



When the changes for the set are complete, click the back button and save the project.

19.3 Update single sets using projects

To update a single set, click the update button for the required set, ok the confirmation prompt to continue to the update.

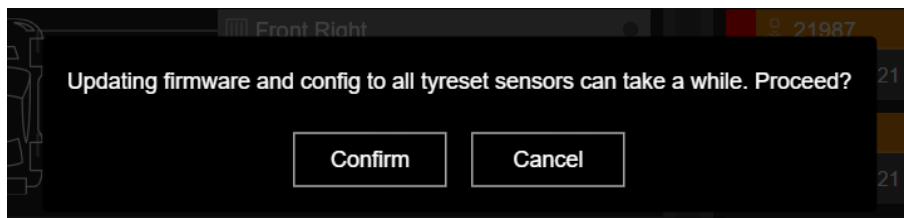

The update process box will show to indicate the update status.

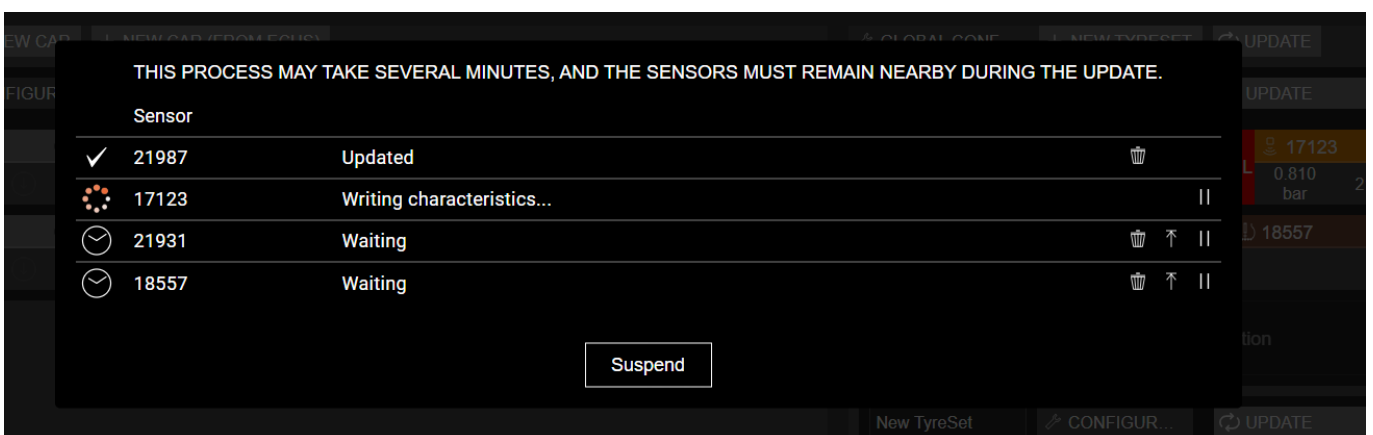

When the update has completed, the process page will show any sensors that failed to update and their reason for the failure.

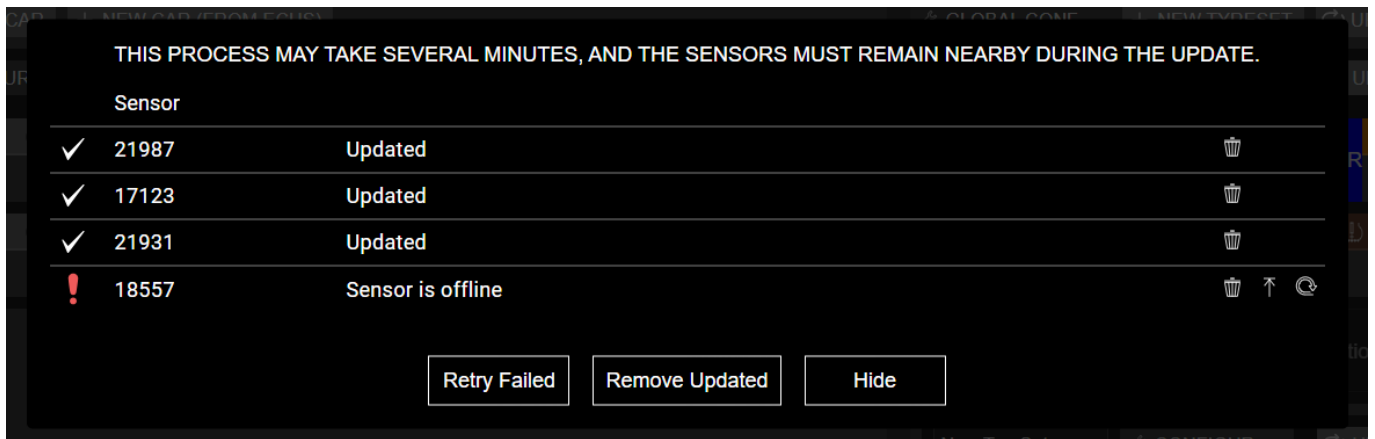

If you choose to hide the process pane during the update, an indication that an update is in process will be shown at the top of the page.

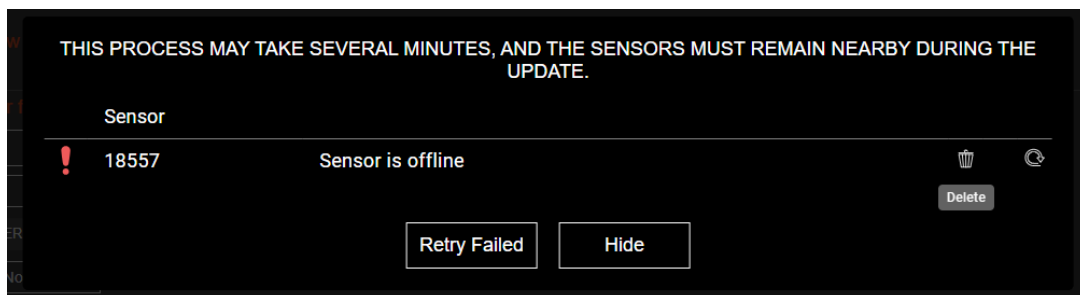
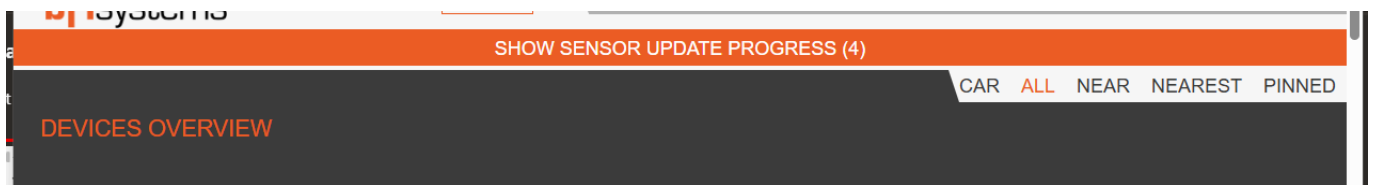

19.4 Update a single sensor using projects

To update a single sensor, click on the selected sensor, the comparison page will open, you may need to read the config from the sensor.

The differences between the selected sensor and the project will be highlighted.

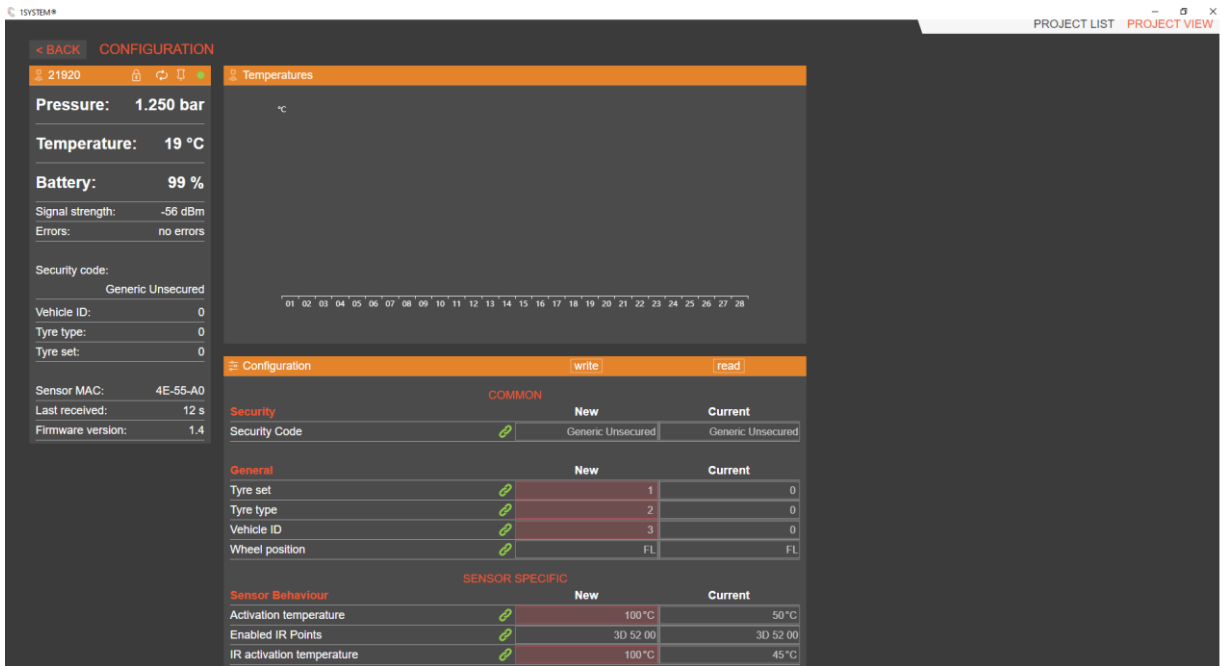

If you do not want to update 1 or more of the parameters you can unlink by clicking the link icon so it turns grey

Change the parameter values that are unlinked to match what is in the current sensor then write your updated parameters.

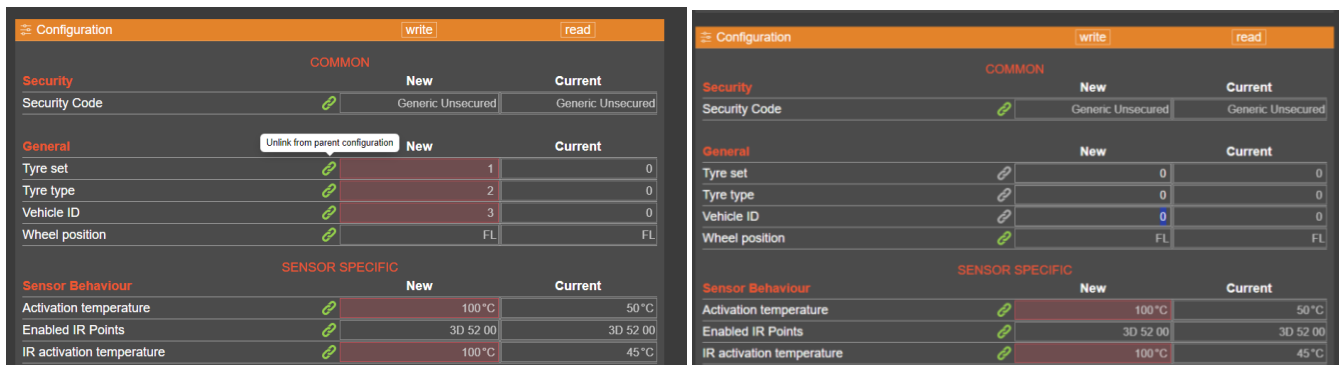

The sensor will be updated to the new parameters.

19.5 Batch updating sets using projects

Sensors can be updated in batches of sets or single sets, if updating multiple sets, click the 'Update' button for each set then use the 'Hide' button to access the main page again then click 'Update' for the next set and they will be added to the update list when the Update button is selected.

19.6 Batch updating single sensors using projects

If you wish to update multiple sensors so all contain the same settings, more than 4 sensors can be added to the update pane, these will be shown in the update list when the Update button is selected.

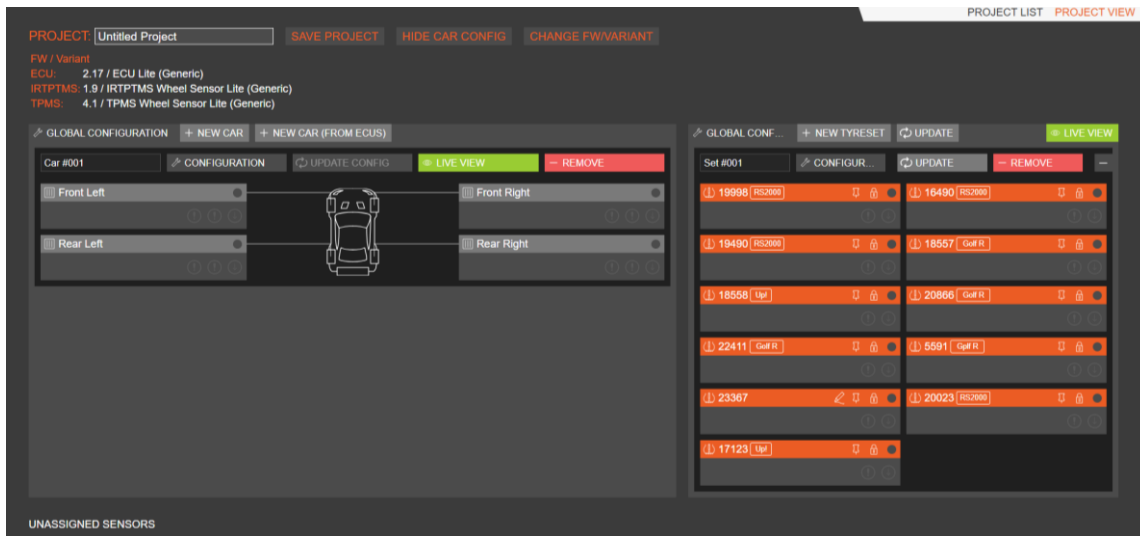

19.7 ECU Update using projects

Ensure your ECU firmware settings are correct, see Figure 101.

In a new project, the generic configuration can be viewed by selecting the CONFIGURATION button, Note, if the GLOBAL CONFIGURATION has been altered within the project, the updated parameters will be shown.

To make a global change for ECUs connected to the project, select the GLOBAL CONFIGURATION button, the parameter list will be displayed.

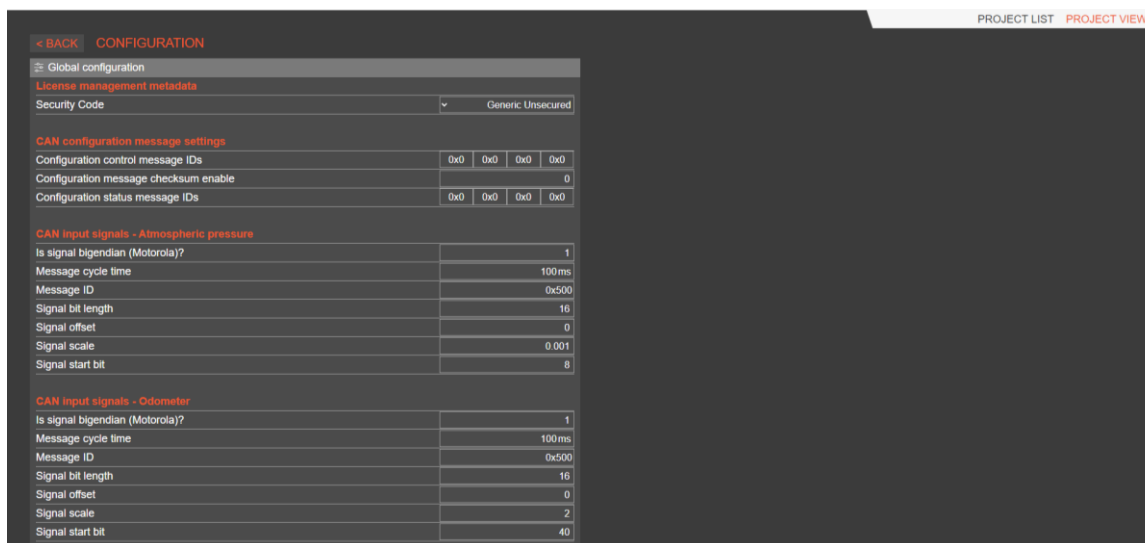
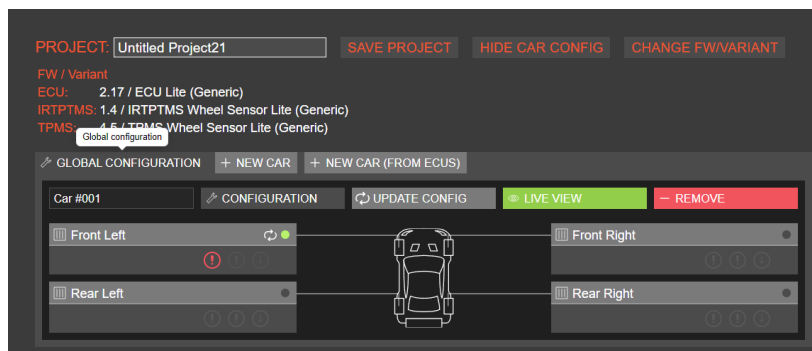

Figure 108 - ECU Global Configuration

20 Confirming Acceptable Reception of Each ECU

Each ECU will receive any TPMS sensor with the correct security that is within the vicinity and has a strong enough signal to be received.

All received sensors are continuously ranked in the list of candidates based solely on their RSSI.

When the vehicle is stationary, the sensor with the strongest average signal is determined to be the closest wheel to the ECU and is set as detected (0x0) by the ECU and therefore positioned. The sensor must have been received in the past 8s, and the signal strength must be stronger than the configurable minimum signal strength (Set to -60dBm by default).

For this reason, the RSSI for the closest wheel sensor is required to be sufficiently higher than the RSSI for the other wheels on the car.

To confirm the RSSI level for each of the sensors received, the ECU transmits the signal strengths and serial numbers for each sensor in the TPMS_XX_DIAG messages (0x714, 0x715, 0x716 & 0x717).

The message is transmitted as a multiplexed message with 8 levels of MUX, each multiplex is a buffer within the ECU memory. As a sensor is received the buffers are filled from buffer 1.

A buffer that has a very weak signal or has not been updated for 8 seconds will become available again once all buffers have been used.

Signals - TPM1S_XX_DIAG_ADV_ID_XX
TPM1S_XX_DIAG_ADV_RSSI_XX

The signal can be checked in the logged data by checking all 8 MUX in a single graph as shown below:

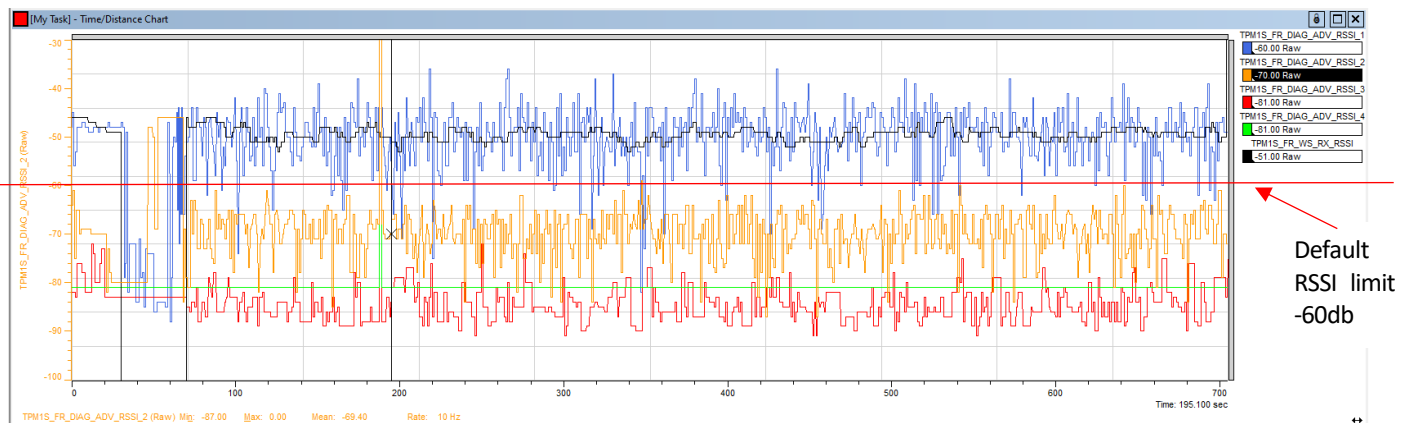

Figure 109 - RSSI of each sensor received by the ECU

Figure 109 shows the RSSI for MUX TPM1S_FR_DIAG_ADV_RSSI_1 is the strongest with the RSSI for TPM1S_FR_DIAG_ADV_RSSI_2, 3 and 4 being below the -60dBm RSSI limit cut off level within the ECU.

The graph also shows the average RSSI used by the ECU to determine the detected sensor TPM1S_FR_WS_RX_RSSI.

With the wheel closest to the ECU above the cut off level and the other 3 wheels below the cut off level, the system will detect the correct wheel for this position.

The same parameters should be checked for each of the ECUs fitted to the car.

21 1SYSTEM® ECU Wiring Schematic

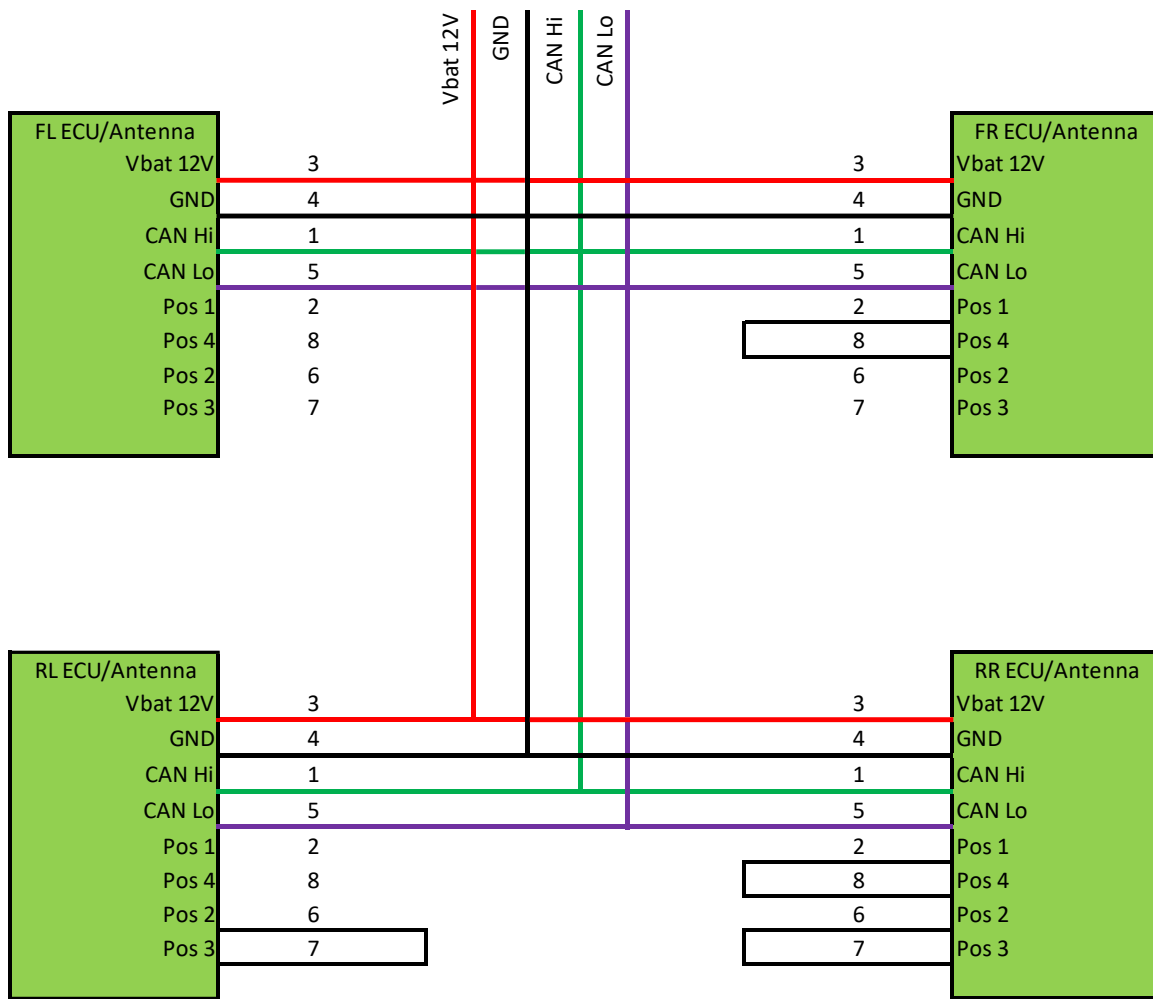

Figure 110 - Wiring schematic for Lite ECUs

A 5A fuse should be placed inline of the 12v supply line.

22 CAN Specification

A CAN specification and dbc file will be supplied to customers of the system and can be downloaded from the same link sent for the 1SYSTEM® PC app, if you have not received these please request by sending an email to 1system@bf1systems.com

23 System Errors and Warnings

The 1SYSTEM® TPMS transmits warnings on the CAN bus to indicate the status of the system.

CAN message	Signal name	Warning function	Range	Value description
TPM1S_FL_WS_DATA TPM1S_FR_WS_DATA TPM1S_RL_WS_DATA TPM1S_RR_WS_DATA	TPM1S_XX_WS_ACCEL_ERR	The accelerometer has a maximum g force rating, this signal indicates when the accelerometer has gone out of range. The signal can be ignored if set whilst on track but if set whilst stationary will indicate a defective accelerometer	0-1	0x0 = False 0x1 = True
	TPM1S_XX_WS_BATTERY_ERR	Voltage reading fault. Sensor is unable to read the battery voltage	0-1	0x0 = False 0x1 = True
	TPM1S_XX_WS_TEMP_ERR	Internal temperature reading fault. Sensor is unable to read the internal temperature	0-1	0x0 = False 0x1 = True
	TPM1S_XX_WS_PRESS_ERR	Pressure reading fault. Sensor is unable to read the pressure	0-1	0x0 = False 0x1 = True
	TPM1S_XX_WS_FAULT_GROUP	bf1systems sensor fault codes	0-7	0x0 No Fault 0x1 TPMS Subsystem 0x2 IR Subsystem 0x3 Core 0x4 Firmware Fault 0x5 Unknown Fault 0x6 Abnormal Reset 0x7 Reserved
	TPM1S_XX_WS_MISMATCH	If an ECU detects a sensor with the wrong security code to be the closest and is not able to detect any other sensors with the correct security code the error will be set. No other TPMS data will be transmitted for a sensor with incorrect security.	0-1	0x0 = False 0x1 = True
	TPM1S_XX_WS_HIGH_TEMP_WRN	Wheel sensor ambient temperature above limit set in ECU configuration	0-1	0x0 = False 0x1 = True
	TPM1S_XX_WS_UNDER_PRESS_SOFT_WRN	Pressure loss delta greater than soft warning limit	0-1	0x0 = False 0x1 = True
	TPM1S_XX_WS_UNDER_PRESS_HARD_WRN	Pressure loss delta greater than hard warning limit	0-1	0x0 = False 0x1 = True
	TPM1S_XX_WS_GAS_LOSS_WRN	Rapid pressure loss greater than warning limit	0-1	0x0 = False 0x1 = True
TPM1S_XX_WS_RUN_FLAT_WRN	No pressure in tyre	0-1	0x0 = False 0x1 = True	
TPM1S_FL_WS_INFO TPM1S_FR_WS_INFO TPM1S_RL_WS_INFO TPM1S_RR_WS_INFO	TPM1S_XX_WS_RX_TIMEOUT	Wheel sensor not received for 6 seconds	0-1	0x0 = False 0x1 = True
	TPM1S_XX_WS_BATTERY_LOW	Wheel sensor battery low voltage	0-1	0x0 = False 0x1 = True
	TPM1S_XX_WS_RBL_LOW	Wheel sensor remaining battery life equal or below limit set in ECU configuration	0-1	0x0 = False 0x1 = True

	TPM1S_XX_WS_NOT_DETECTED	No wheel sensor detected by the ECU	0-1	0x0 = Detected 0x1 = Not detected
	TPM1S_XX_WS_NOT_CONFIRMED	Wheel sensor not confirmed by the ECU	0-1	0x0 = Confirmed 0x1 = Not confirmed
TPM1S_FL_ECU_INFO TPM1S_FR_ECU_INFO TPM1S_RL_ECU_INFO TPM1S_RR_ECU_INFO	TPM1S_XX_ECU_HIGH_TEMP	ECU temperature too high	0-1	0x0 = False 0x1 = True
	TPM1S_XX_TIMESTAMP_RX_TIMEOUT	Timestamp CAN signal missing	0-1	0x0 = False 0x1 = True
	TPM1S_XX_ATM_PRESS_RX_TIMEOUT	Atmospheric pressure CAN signal missing	0-1	0x0 = False 0x1 = True
	TPM1S_XX_VEH_SPEED_RX_TIMEOUT	Speed CAN signal missing	0-1	0x0 = False 0x1 = True

24 Tyre pressure warnings

24.1 Gauge / absolute pressure (CAN signal 'TPM1S_XX_WS_PRESS')

Gauge pressure is the value read using a manometer, this is the pressure measured above atmospheric pressure.

When the ECU is supplied with atmospheric pressure, recommended by bf1systems for better accuracy, the pressure transmitted over CAN will be in Gauge.

If the Vehicle data Rx message, containing atmospheric pressure, is not transmitted to the ECU, the tyre pressures will be transmitted as a gauge value using a default atmospheric pressure of 1013mBar.

If an absolute pressure, is needed to be transmitted from the TPMS so atmospheric pressure can be subtracted by the logger, then a value of 0 should be transmitted to the ECU for atmospheric pressure.

$$P_{\text{gauge}} = P_{\text{abs}} - P_{\text{atmos}}$$

24.2 Compensated pressure (CAN signal 'TPM1S_XX_WE_P_COMP')

Compensated pressure is the value used to calculate the warnings; this is calculated using temperature compensation from the actual pressure @25°C.

$$P_{\text{comp}} = (P_{\text{abs}} * (273 + 25) / (273 + \text{Temp})) - P_{\text{atmos}}$$

24.3 Reference pressure (CAN signal 'TPM1S_XX_WE_P_REF')

When automatic pressure calibration is enabled then P_{ref} is set equal to P_{comp} (note 1) after the vehicle starts moving (note 2):

$$P_{\text{ref}} = P_{\text{comp}}$$

Notes:

1. P_{comp} is filtered to reject short term noise for purpose of setting P_{ref} .
2. The vehicle must be moving faster than *Moving Speed** for *Moving Time**.

24.4 Flat tyre warning (CAN signal 'TPM1S_XX_WS_RUN_FLAT_WRN')

The flat tyre warning signal is set when:

$$P_{\text{gauge}} \leq \text{Run Flat Pressure (gauge)*}$$

24.5 Low pressure soft warning (CAN signal 'TPM1S_XX_WS_PRESS_SOFT_WRN')

The low-pressure soft warning signal is set when:

$$P_{\text{comp}} \leq P_{\text{ref}} - \text{Low Pressure soft (delta)*}$$

24.6 Low pressure hard warning (CAN signal 'TPM1S_XX_WS_PRESS_HARD_WRN')

The low-pressure hard warning signal is set when:

$$P_{\text{comp}} \leq P_{\text{ref}} - \text{Low Pressure hard (delta)*}$$

24.7 Rapid pressure loss warning (CAN signal 'TPM1S_XX_WS_GAS_LOSS_WRN')

The rapid gas loss warning signal is set when the tyre has lost more pressure than *Rapid Pressure Loss** during the previous 60 seconds:

$$P_{\text{comp}} \leq P_{\text{comp}@t-60s} - \text{Rapid Pressure Loss*}$$

*Characteristics set for the ECU

25 ECU product markings

25.1 Lite ECU

The ECU Antenna is laser marked to show the information detailed below:

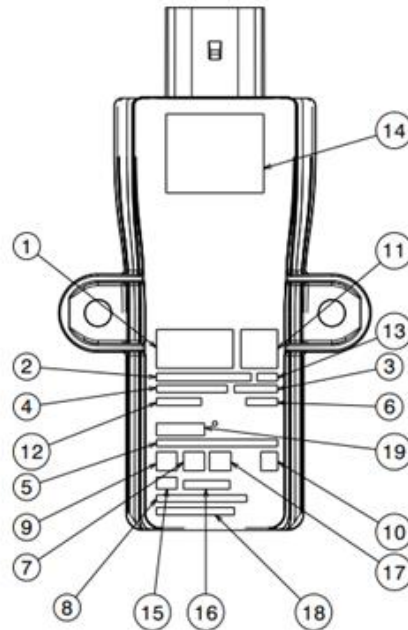

	Description	Marking Detail
1	Manufacturer Logo	Symbol
2	Device Designation	1SYSTEM ECU Lite
3	Model Number	BF24G1EC
4	Part Number	F1-100-1799-0XX
5	MAC Address	XX:XX:XX:XX:XX:XX
6	Production Date	DD/MM/YYYY
7	Type Approval Symbol FCC	Symbol
8	Type Approval ID FCC	FCC USX-BF24G1EC
9	Type Approval Symbol CE	Symbol
10	WEEE Symbol	Symbol
11	MAC Address Data Matrix	2D Barcode (type ECC200)
12	Country of Origin	Made in UK
13	IP rating	IP6K7
14	Customer Information	If Applicable - Label for Customer
15	Type approval symbol Giteki (MIC-R)	Symbol
16	Type approval ID Giteki (MIC-R)	205-21076
17	Type Approval Symbol UKCA	Symbol
18	Type Approval ID IC	IC 11262A-BF24G1EC
19	Serial No.	XXXXXX

Figure 111 - 1SYSTEM® ECU product markings

Note: bf1systems Ltd reserve the right to edit/amend/change the product markings and any marking positions on the product without notice

25.2 Pro ECU

The Pro ECU uses the same markings as the Lite with the following change:

	Description	Marking Detail
2	Device Designation	1SYSTEM ECU PRO

26 Wheel sensor product markings

26.1 TPMS sensor

The Wheel Sensor is laser marked to show the information detailed below.

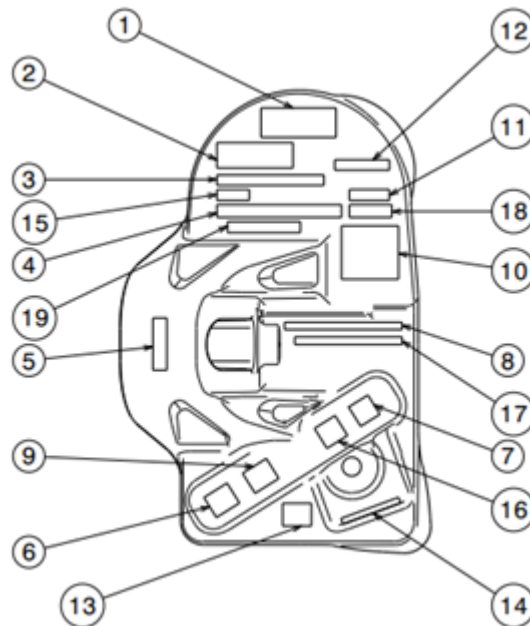

	Description	Marking Detail
1	Manufacturer Logo	Symbol
2	Device Designation	1SYSTEM TPMS Wheel Sensor Lite
3	Part Number	F1-100-1800-002
4	MAC Address	XX:XX:XX:XX:XX:XX
5	Torque Setting	4.5Nm
6	Type Approval Symbol CE	Symbol
7	WEEE Symbol	Symbol
8	Type Approval ID FCC	FCC USX-TP24G1WE
9	Type Approval Symbol FCC	Symbol
10	MAC Address Data Matrix	2D Barcode (type ECC200)
11	Production Date	DD/MM/YY
12	Model Number	TP24G1WE
13	Type approval symbol Giteki (MIC-R)	Symbol
14	Type approval ID Giteki (MIC-R)	205-21077
15	Country of Origin	Made in UK
16	Type Approval Symbol UKCA	Symbol
17	Type Approval ID IC	11262A-TP24G1WE
18	Sensor Validation Code (SVC)	XXX
18	Serial No.	XXXXXX

Figure 112 - TPMS product markings

Note: bf1systems Ltd reserve the right to edit/amend/change the product markings and any marking positions on the product without notice

26.2 IRTPMS Sensor

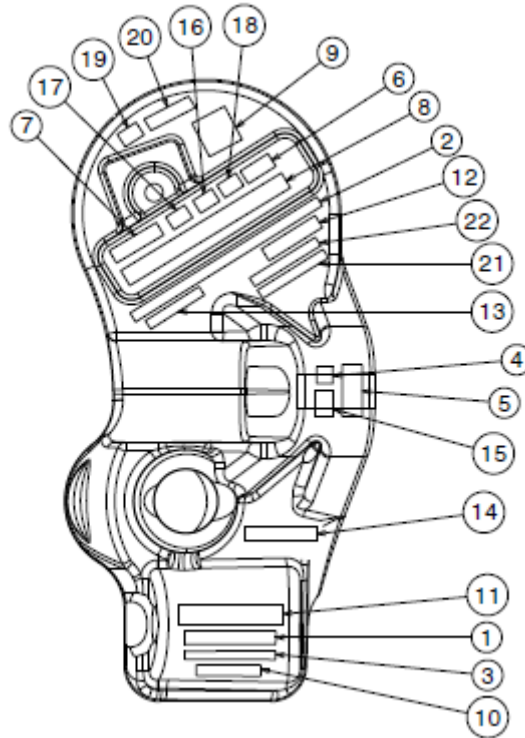

Item Location	Item Description	Item Marking Detail
1	bf1systems Part No.	bf1 PN here
2	Device Designation	Variant Description here
3	Customer Part Number	Customer PN here
4	Development Status	HXX Status here
5	Torque Setting	X NM here
6	Sensor Validation Code (SVC)	XXX
7	Serial No. (6 Digit)	XXXXXX
8	MAC Adress	XX:XX:XX:XX:XX:XX
9	Data Matrix ECC 200	2D Barcode
10	Production Date	DD/MM/YY
11	Manufacturer Symbol/Logo	bf1systems Symbol/Logo
12	Model Number	TP24G1WE
13	Country of Origin	Made in UK
14	Pixel 1 Identifier	Pixel 1 this end →
15	WEEE Directive marking	Symbol
16	Type Approval Designation CE Approval Sign RED 2014/53/EU	Symbol
17	Type Approval Symbol FCC	Symbol
18	Type Approval Symbol UKCA	Symbol
19	Type Approval Symbol Giteki (MIC-R)	Symbol
20	Type Approval Symbol ID Giteki (MIC-R)	205-21077
21	Type Approval ID FCC	FCC USX-TP24G1WE
22	Type Approval ID IC	11262A-TP24G1WE

Figure 113 - IR TPMS product markings

Note: bf1systems Ltd reserve the right to edit/amend/change the product markings and any marking positions on the product without notice

27 bf1system Track Link dongle

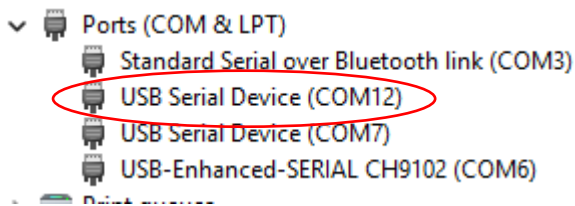

Figure 114 - bf1systems Track Link dongle

The Track Link dongle enables faster, more reliable firmware and characteristic updates because it does not depend on Microsoft to allocate resources to the Bluetooth capability.

The dongle, not relying on the windows operating system, has increased reliability when updating stacks of tyres.

The Track Link dongle instals as a com port device.



When first plugged into the PC, a port is automatically detected, this dongle may change the port several seconds after it has been installed so the software should not be opened in the 30 seconds following the dongle insertion.

Part number to order the Track Link dongle is **F1-100-1851-004**.

28 Valve and Sensor Fitting Instructions

The valve fitting instructions cover a different range of sensors. Please use the table below to identify the sensor you have as recommended torque settings and wheel sensor screw kits vary depending on the sensor type and/or sensor serial no. Screw kits are supplied as part of the valve kits but can be purchased separately.

<p>Sensor type</p> <p>Part # F1-XXX-</p>		<p>TPMS sensor</p> 			
Installation part	Part no.	Qty req'd per wheel/sensor	Wheel sensor screw torque	Wheel sensor screw Loctite	Wheel valve Hex nut torque
Sensor screw kit	F1-70-6934-B	1	4.5Nm (Torx head)	Screw pre-impregnated	6Nm

<p>Sensor type</p> <p>Part # F1-XXX-</p>		<p>IRTPTMS sensor</p> 			
Installation part	Part no.	Qty req'd per wheel/sensor	Wheel sensor screw torque	Wheel sensor screw Loctite	Wheel valve Hex nut torque
Sensor screw (High strength) kit	F1-02-7561-A	1	7.0 Nm (Hex head)	Use Loctite 242 (Loctite not supplied)	6Nm

Table 9: Sensor installation torques

For ease and to speed up the identifying of wheel sensors once they are installed in the wheel assemblies, we recommend that a sticker is placed on each rim with the serial number of the sensor fitted to the rim. Typically, these numbers are placed on the rim in the immediate vicinity of the valve.

The serial numbers for each sensor type are shown in Figure 115 and Figure 116, highlighted in yellow.



Figure 115 - 1SYSTEM® TPMS Wheel Sensor Serial Number



Figure 116 - 1SYSTEM® IRTPTMS Wheel Sensor Serial Number

28.1 Tools Required

The tools required to install the valve are:

- Torque Wrench (With capability to be set to 6Nm and 7Nm)
- 11mm Deep socket
- 4mm hex drive bit



Figure 117 - Torque wrench

28.2 Valve Kit Parts

The valve kit consists of the following:

1. Valve caps
2. Hex nut
3. Washer
4. Valve stem (the stem will have the core and seal fitted when new)
5. Torque bar

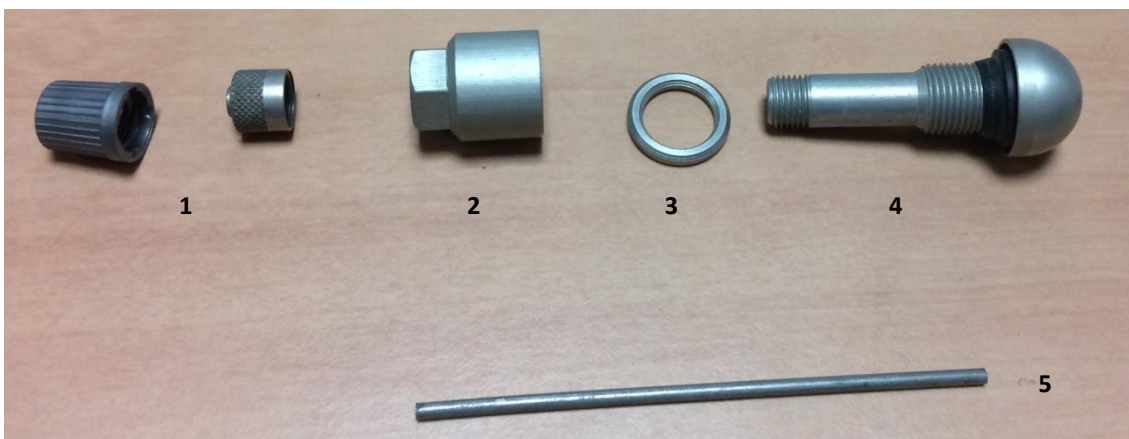

Figure 118 - Valve kit

The TPMS sensor uses the standard bolt.

The IRTPMS sensor uses the High Strength bolt, see 28.4

NOTE: Valve kits may vary depending on rim design, for fitting alternative valves please contact bf1systems

28.3 Valve Installation

If fitted, remove the existing valve from the rim.

Check there are no sharp edges on the valve mating surfaces that could cause damage to the seal and the spot face is clean.



Figure 119 - Valve mounting face

Insert the valve stem through the rim from the internal face, the small torque bar hole in the valve stem dome should be pointing up from the rim.



Figure 120 - Valve fitted to rim

Fit the washer and the hex nut to the stem, place the torque bar in the stem dome hole then whilst holding the torque bar to stop the stem rotating, tighten the hex nut to **6Nm (this torque must not be exceeded)**.



Figure 121 - Valve torque bar

Fit the desired valve cap



Figure 122 - Valve cap options

28.4 Fitting the 1SYSTEM® IR Using the High Strength Bolt Kit

Sensor assembly consists of the following parts:

1. IRTPMS Wheel sensor
2. Load spreading washer
3. Lock washer
4. bf1systems hex bolt
5. Loctite 243

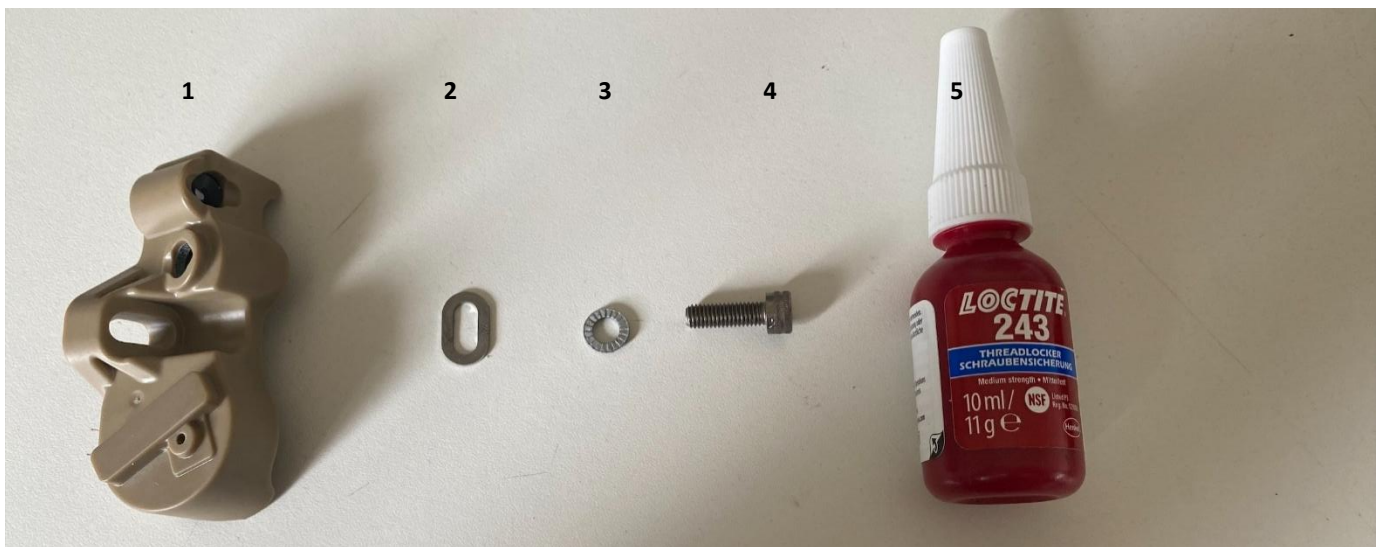

Figure 123 - High strength screw kit

Place the locking washer and the load spreading washer on the bolt and apply Loctite to the thread.



Figure 124 - Assembled screw with Loctite

Place the sensor on the dome of the valve and screw in the high strength bolt assembly.

Ensure the feet of the sensor are touching the rim and no other part of the sensor housing is touching the rim.



Figure 125 - IR sensor mounted on rim

Torque the bolt to **7Nm**.



Figure 126 - Torque to 7Nm

28.5 Fitting Notes

DO NOT ROTATE THE VALVE BODY OR TWIST THE SENSOR ONCE THE VALVE ASSEMBLY HAS BEEN INSTALLED, THIS WILL CAUSE THE VALVE TO LOOSEN AND THE VALVE NUT WILL THEN REQUIRE RE-TORQUING.

THE TORQUE SETTING FOR THE HEX SCREW IS DESIGNED TO SLIGHTLY DEFORM THE SENSOR'S HOUSING, TO ENSURE THAT IT IS FITTED WITH MAXIMUM SECURITY.

THE SENSORS ARE NOT DESIGNED TO BE REPEATEDLY REMOVED FROM THE WHEEL; THEY SHOULD BE FITTED TO RIMS AND LEFT IN SITU FOR AS LONG AS POSSIBLE – i.e., THE LIFE OF THE RIM/SENSOR. PLEASE DO NOT REMOVE SENSORS UNNECESSARILY.

IF A SENSOR IS REMOVED FROM A RIM IT IS ESSENTIAL THAT IT IS FITTED TO THE SAME RIM TYPE AS BEFORE, I.E. DO NOT INTERCHANGE FRONT SENSORS WITH REAR SENSORS.

HEX BOLTS: IF A NEW BOLT IS FITTED OR THE OLD BOLT IS RE-USED THEN IT IS ESSENTIAL THAT THE BOLT IS CLEANED AND LOCTITE 243 IS APPLIED PRIOR TO INSTALLATION.

29 Recommended Procedures and Maintenance

29.1 Preserving Wheel Sensor Battery Life

It is always recommended that the air is released from the wheel assembly after each race weekend.

The wheel sensor enters a sleep state when the pressure is below 0.115 bar, and this state reduces the drain on the battery by increasing the time between monitoring for pressure changes and disabling other functions that are not needed in this state.

Wheel sensors that are stored in a pressurised wheel will be regularly checking for changes in pressure, will continuously be checking for ECU connections and will start to transmit if subjected to a shock hard enough to set the accelerometer to its moving state, all of which will use up the battery faster than if the sensor was in an unpressurised state.

29.2 Wheel Cleaning

Do not wash the wheel with the sensor fitted, doing so could damage the internal pressure/temperature sensor and leave dirt or marks on the lens of the IR element resulting in an offset in the IR temperature reading.

29.3 Buying or selling a system from another team

If you sell your system to another team, they will not have your security licence available to them so will not be able to use the parts. Before selling, the sensors and ECUs should be set back to the generic security.

Any team buying second hand parts should make sure the security has been set to generic.

30 Troubleshooting

30.1 SRW (Short Range Wireless) not connecting

When the software is first opened, the SRW may show as 'connecting' until it receives a sensor.

The SRW will show as 'connecting' until it has received a sensor and confirmed the connection.

If your SRW connection shows continuously as 'disconnected' you will not be able to receive the wheel sensors.

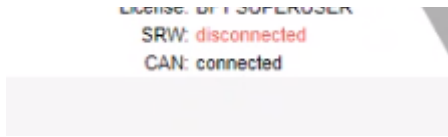

Check the connection to the PC is switched on:

Select the device from the start menu - Start-Settings-Devices-

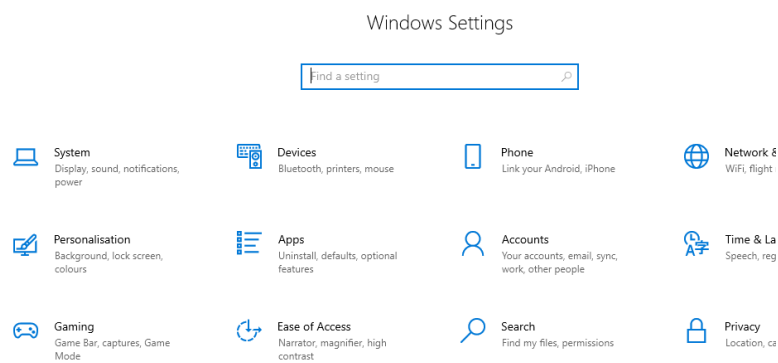

Figure 127 - Windows settings page

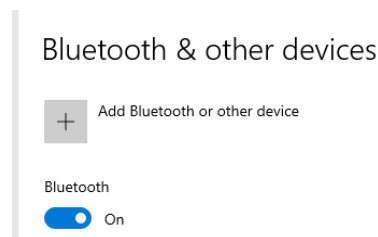

Figure 128 - Toggle device Off then On

If the device is switched on, switch off then back on

30.2 Sensor fails configuration update

Sensor no longer within the 2.4GHz wireless range

Sensor is being moved/shocked into moving mode

Sensor is above 85°C

30.3 No CAN connection to ECU

When using a Peak P-CAN to USB adaptor and the app does not connect to an ECU, check the settings are correct for your adaptor.

If the problem continues, confirm if the PCAN Basic API has been installed, you may need to reinstall the Peak software to update the drivers.

30.4 No CAN connection following application restart

If you close the app then re-open in quick succession the CAN comms does not reset, leave the software for 30 seconds then click on the CAN: **disconnected**, the CAN should reconnect



30.5 Sensor displayed freezes

Some laptops have been seen to struggle with the Bluetooth connection when in a paddock surrounded by several teams using 1SYSTEM, to stop this, check the Windows Power Mode by selecting the Windows Settings – System – Power & battery and check the Power Mode, this will usually be set to Balanced, change to Best performance



Figure 129 - Windows Power mode

30.6 Licence not recognised

New licence's and licence updates are carried out as an over the air update.

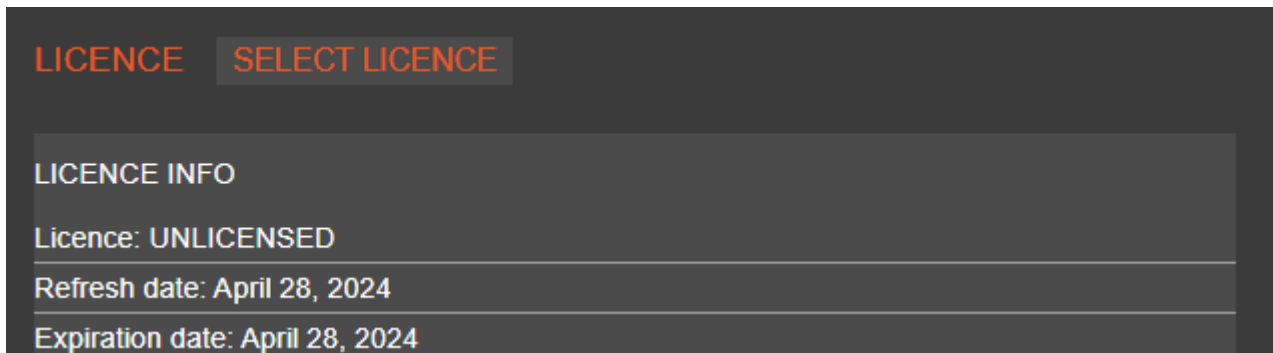

Figure 130 - Software not licenced

If you have received an email confirming you have been issued a new or updated licence, but when you open the 1SYSTEM app you have a message saying the software is UNLICENSED, first check that your PC has a connection to the internet. Because the software uses over the air updates for the licence, you need to have a good internet connection.

If the software remains unlicensed, you may have issues with your PC security and permissions, use the address below to check if your PC is able to access the licence server page.

<https://api.1system.app/swagger>

If you have access, you will see the page shown below.

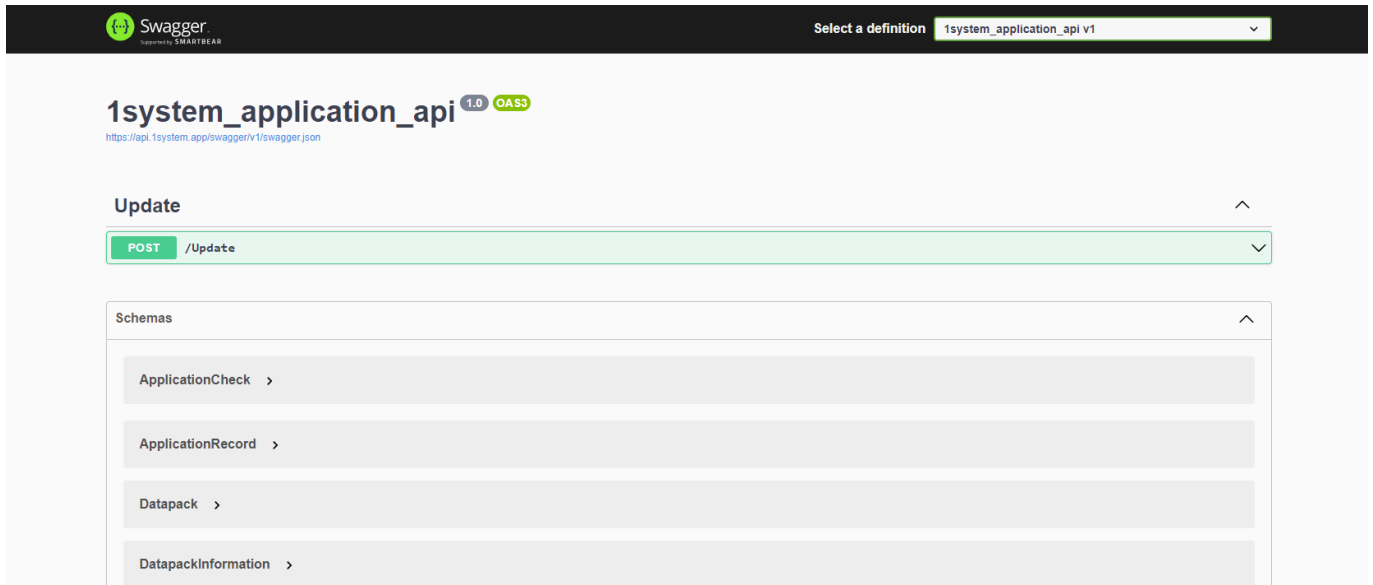

Figure 131 - bf1system licence server web page

If you do not have access to this page, you will need to speak with your IT department to gain access.

30.7 1SYSTEM app will not run

With a new instal or sometimes with an update it may be required to update the .NET software, this involves updating 2 separate .NET files:

```
aspnetcore-runtime-8.0.16-win-x64 *  
windowsdesktop-runtime-8.0.16-win-x64 *
```

*file version correct at time but may change, instal the latest version.

31 Certifications

31.1 Brazil



Figure 132 – Brazil certification

Modelo (Model): TP24G1WE

Este equipamento não tem direito à proteção contra interferência prejudicial e não pode causar interferência em sistemas devidamente autorizados.

Para maiores informações, consulte o site da ANATEL www.gov.br/anatel/pt-br/

“This equipment is not entitled to protection against harmful interference and may not cause interference in duly authorized systems.”

31.2 TRA-063588/ TRA-063741 Safety testing

The TPMS sensor is classed as MS1 for mounting which is no safety precautions required. This is for equipment <1 kg and mounted at a height <2 m. Clause 8.2.1.e states:

Equipment is only suitable for mounting at heights ≤ 2 m.